



MODEL 2851-OWI
MODEL 2852-OWI
Oil/Water Interface Monitor

User Manual

Technical Support
Continental North America Toll Free 1-(800) 387-9487
Ph: +1 (905) 829-2418 Fx: +1 (905) 829-4701



A Product of Arjay Engineering Ltd.
Oakville, Ontario, Canada

www.ArjayEng.com

MODEL:	
HARDWARE NO.:	5.1
SOFTWARE NO.:	
SERIAL NO.:	

TABLE OF CONTENTS

1.0	INSTRUMENT OVERVIEW	3
1.1	Features	3
1.2	Model Number Table.....	3
1.3	Specifications	4
2.0	INSTALLATION.....	6
2.1	Controller Installation	6
	2.1.1 Permanent Power Connection (AC Powered Models only)	6
2.2	Probe Installation	7
2.3	Electrical Installation	10
	2.3.1 Input / Output Terminal Specification	11
2.4	Glossary of Symbols	12
3.0	STARTUP AND CALIBRATION.....	13
3.1	Startup.....	13
3.2	Menu Flow Chart Background Information	13
	3.2.1 Menu Description.....	13
	3.2.2 Menu Flow Chart	13
	3.2.3 Data Entry.....	14
3.3	2850 Controller Setup	14
	3.3.1 Setup Menu	14
	3.3.2 Alarm Menu	15
3.4	2850 Controller Calibration	16
	3.4.1 Auto Calibration	16
	3.4.2 Manual Calibration.....	17
4.0	2850 Controller Network	18
4.1	Modbus Configuration.....	18
4.2	2800 Series Modbus Register Mapping.....	19
5.0	MAINTENANCE	20
6.0	TROUBLESHOOTING	21
7.0	FLOW CHARTS	22

TABLE OF FIGURES

Figure 1 – Probe Installation	8
Figure 2 – Typical Installation Vertical	9
Figure 3 – Typical Installation Angled	9
Figure 4 – Electrical Installation Overview	10

1.0 INSTRUMENT OVERVIEW

The 2851-OWI and 2852-OWI sensing probe monitors the capacitance field around the active probe. As the oil/water interface level moves up and down the probe, the capacitance change in picofarads (pF) is monitored by the Arjay processor and translated into a 4-20 mA proportional output and Modbus RS-485 communication.

After the probe is installed and the vessel is filled with liquid, a calibration will be required by entering the % value of two different oil/water interface levels. The oil/water interface level must be physically changed in the vessel to allow the unit to match your entered % interface level against the pF reading of the probe.

The model is intended for use in General Purpose non-hazardous areas. For hazardous location use refer to Arjay Engineering Ltd. For appropriate model.

1.1 Features

- Microprocessor based capacitance level Monitor
- 4-20mA proportional output with optional signal isolator
- 4-20 mA can be:
 - Direct acting 4 to 20 mA = 0% water (100%oil) to 100% water (0% oil) or
 - Indirect acting 4 to 20 mA = 0% oil (100% water) to 100% oil (0% water)
- Modbus protocol via RS-485 for access by Arjay handheld, Central Access Panel or compatible system
- Local 2 point Auto or Manual calibration or remote calibration via network
- User specified custom features may be added by contacting Arjay Engineering Ltd.

1.2 Model Number Table

MODEL	DESCRIPTION
2851-OWI	REMOTE MOUNTED 4-20mA (isolated)
2852-OWI	REMOTE MOUNTED 4-20mA (non-isolated), two alarm relays

** The designation 2851 and 2852 will be interchangeable with 2850 throughout this manual.*

1.3 Specifications

Power Input:	12 VDC +15% /-10% or 24 VDC +15% /-10%, 250mA maximum 100VAC – 240VAC +/- 10%, 50/60 Hz, 150mA maximum Note: DC input models must be supplied by Limited Energy power source. Limited Energy means compliance with one of the following requirements: <ul style="list-style-type: none"> - Class 2 circuit according to Canadian Electrical Code, Part, I, C22.1; - Class 2 circuit according to National Electrical Code, NFPA-70; - Limited Power Supply (LPS) according to IEC 60950-1; - Limited-energy circuit according to IEC 61010-1.
Connections to mains supply	Permanent (for AC/DC model)
User Interface:	
Display & Keypad	Two line LCD with Alarm status display, select menu or enter values by keypad (display is internal to housing and used for set-up and diagnostics only)
Communication Interface:	Modbus (RS485)
Analog /Relay Outputs:	
mA Signal Output	4-20 mA DC, 900 Ohms max OR 450 Ohms max (12VDC Power)
Relay Output	2 SPDT relay, dry, N.O. Contact 5A @ 250 VAC (Resistive) and N.C. Contact 3A @ 250VAC (Resistive), selectable failsafe or non-failsafe, selectable high or low acting alarm, programmable time delay: 0 – 600 seconds
Instrument Performance:	
Measuring Range	0 - 5000 pF (most applications are 100pF to 1000pF)
Accuracy	0.2%
Resolution	0.05% of setpoint via network display 0.002% of Full Scale capacitance via network display
Calibration	Linear 2 point Auto calibration and Manual calibration
Environmental:	
Operating conditions	Continuous
Operating Temperature	-20 °C to +55 °C controller -60 °C to +55 °C PMC -60 °C to + 260 °C probe
Relative humidity	0 to 95% (non-condensing)
Altitude	≤2000 m
Installation Category	II
Pollution Degree	2
Equipment mobility	Fixed

Mechanical Specification:	Refer to Dimensional Drawing
Enclosure Rating	Type 4 / IP65 Painted Steel (Blue) Type 4x / IP66 Polycarbonate (Gray) Type 4x / IP66 316 Stainless Steel
Options on Enclosure	Buzzer Pilot Light OR Strobe/Beacon Custom alarms
Approval Standards:	<ul style="list-style-type: none">• UL / IEC 61010-1, 2nd Edition, 2005-07-22 (Electrical Equipment for Measurement, Control, and Laboratory Use; Part 1: General Requirements)• UL file number: E343390• CAN/CSA-22.2 No. 61010-1, 2nd Edition, 2004-07, (Electrical Equipment for Measurement, Control, and Laboratory Use; Part 1: General Requirements)• CE: UL / IEC 61010-1; IEC / EN 61000-4; ISO 9001:2008

2.0 INSTALLATION

NOTE: If any damage to the instrument is found, please notify an Arjay Engineering representative as soon as possible prior to installation.

2.1 Controller Installation

Choose the mounting location in accordance with good instrument practice. Extremes of ambient temperature and vibration should be avoided (see specifications and installation drawing).

The 2850 controller may be mounted up to one kilometer from the PMC card using a minimum 18 gauge, 2-wire SHIELDED cable.

Check the polarity of the + and - wiring between the controller and the PMC prior to powering on the unit; + to + and - to - to avoid damage. Shield of cable should be connected to secondary ground terminal marked as $\underline{\perp}$. Incoming Earth ground should be connected to primary ground terminal marked \oplus on sub plate.

Important Note: The controller can be set in a Failsafe mode. This means that the relays are in an energized state during normal operation. The N.O. relay contact will be held closed and the N.C. relay contact will be held open during a normal condition. This will allow the relay to return to its non-energized (shelf) state during an alarm, fault or power failure condition. Wire accordingly. Note: Maximum Conduit size for installation size is $\frac{3}{4}$ " FNPT.

2.1.1 Permanent Power Connection (AC Powered Models only)

- 1) Connection to the building wiring system shall be in accordance with the Canadian Electrical Code (CEC), Part 1 in Canada, the National Electrical Code, ANSI/NFPA 70 in the USA, or the local electrical codes of the country where the equipment is being installed.
- 2) A disconnecting device is required. The disconnecting means shall disconnect all current-carrying conductors.
- 3) 15A circuit breaker or equivalent fuse is required.
- 4) An external switch or breaker shall be in close proximity to the equipment and within easy reach of the operator. The switch shall be marked as the disconnecting device for the equipment and include the symbols to its "ON" and "OFF" positions using the following symbols:



Power Off



Power On

- 5) The wiring for AC power should be minimum 18 AWG / 300V or as required by local / country codes.
- 6) After field wiring, the primary wires must be secured to the enclosure by tie-wraps to maintain the separation from the signal wires.
- 7) Wiring diagram for permanent connection: See drawings at the back of this manual.
- 8) Use copper conductors only.

2.2 Probe Installation

The probe length is customer specified for the tank and range of interface to be measured. Teflon coated probes are most typical. Most probes will include an inactive stainless steel sheath on the upper portion of the probe. This is to blind the probe from the affects of entrance nozzles, vapours, and changes in the upper liquid/gas phase.

The active portion of the OWI probe must only see oil, water, or the interface combination of oil and water. If the overall liquid level lowers to expose the active portion of the probe to vapour, the output will indicate a decreasing interface level (less water, more oil).

It is recommended to use a flange, union, or retraction device for easy retraction of the probe from the vessel. This will also assist for routine testing and calibration.

Standard probe entry into a tank is via a 3/4" NPT opening (standard probes) or 1" NPT opening (heavy duty probes). Flanges and concentric shields are available as options. The entrance configuration may vary depending on the application requirements.

TO SCREW IN THE PROBE (THREADED ENTRY) USE A WRENCH ON THE LOWER FITTING ONLY. The probe fittings are compression type with Teflon ferrules assembled by applying torque between the two hex sections. The fittings are sealed at the factory to provide a compression seal capable of withstanding high pressures. Once opened they cannot be reassembled without new ferrules.

The probe orientation can be vertical or angled. The length of the exposed active probe needs to extend the full vertical interface change level (refer to Fig 2 and 3). Concentric shields can be considered for improved linearity. Shields should only be used on clean separations where clogging from a rag (emulsion) layer is not a concern. The following points are important when installing the probe:

- 1- **Reference ground:** This is VERY IMPORTANT for accurate measurements and is typically the metal walls of the tank. For non-metallic tanks, a concentrically shielded probe is recommended in which case the shield provides its own Ground. IMPORTANT: For standard threaded entry and flange entry probes (without concentric shields), make sure the fittings are clean to ensure a GOOD ELECTRICAL CONNECTION BETWEEN THE PROBE HEAD ENCLOSURE AND THE TANK (REFERENCE GROUND).
- 2- **The distance between the probe and the ground reference:** This only applies to probes without concentric shields. The closer the distance to the tank wall, the greater the sensitivity of measurement; too close and bridging problems may occur.
- 3- **The degree of parallelism between the probe and the reference ground:** The probe must be parallel to the reference ground for a linear output signal. Note: the concentric shield option is inherently linear due to the concentric shield.
- 4- **The measurement accuracy may be affected by the temperature change of the material in the tank.** The amount of measurement error depends on the material. If the temperature change is excessive, temperature correction may be required. Contact the Arjay representative for more information.
- 5- **Agitators or moving objects in the tank:** Moving objects in the tank close to the probe such as agitator blades, moving baffles etc. appear as moving ground references to a capacitance probe and will cause measurement errors. In applications where these objects are present, a concentrically shielded probe should be used.

CAUTION: INSTALL THE PROBE WITH CARE: THE TEFLON SHEATH IS USED TO ELECTRICALLY ISOLATE THE METAL PROBE FROM THE LIQUID. DAMAGE CAUSING LEAKS MAY CAUSE READING ERRORS.

NOTE:

To ensure proper operation and electrical safety, make sure the 2852 enclosure and the PMC junction box are electrically grounded.

If the equipment is used in a manner not specified by the manufacturer, the protection provided by the equipment may be impaired.

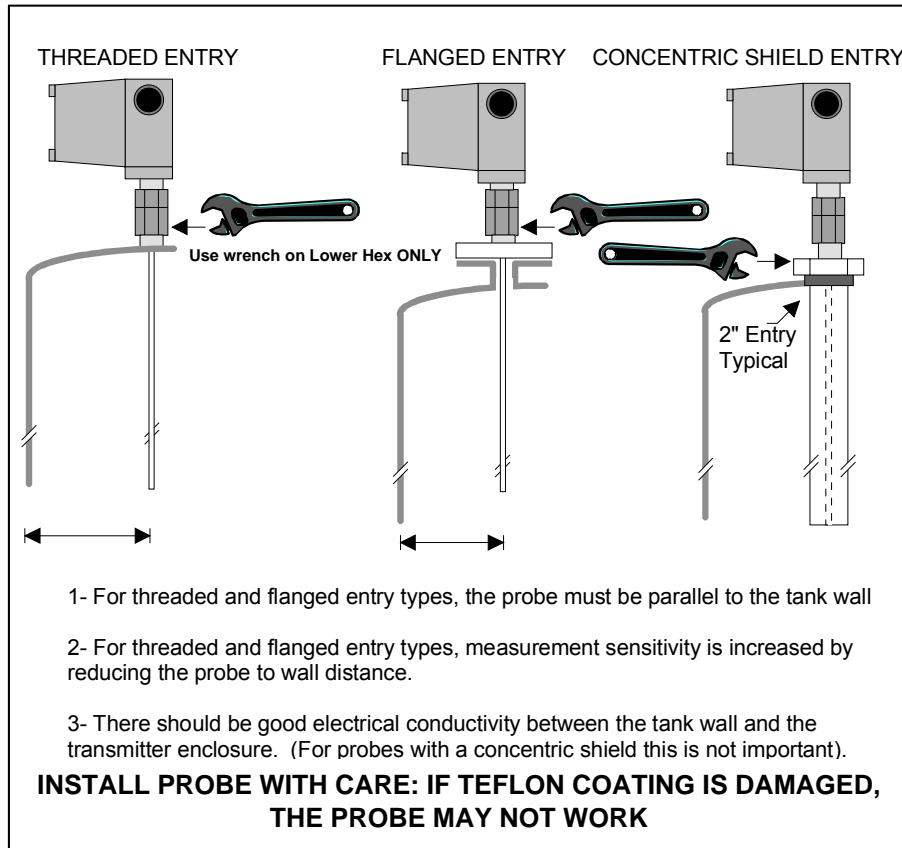

Figure 1 – Probe Installation

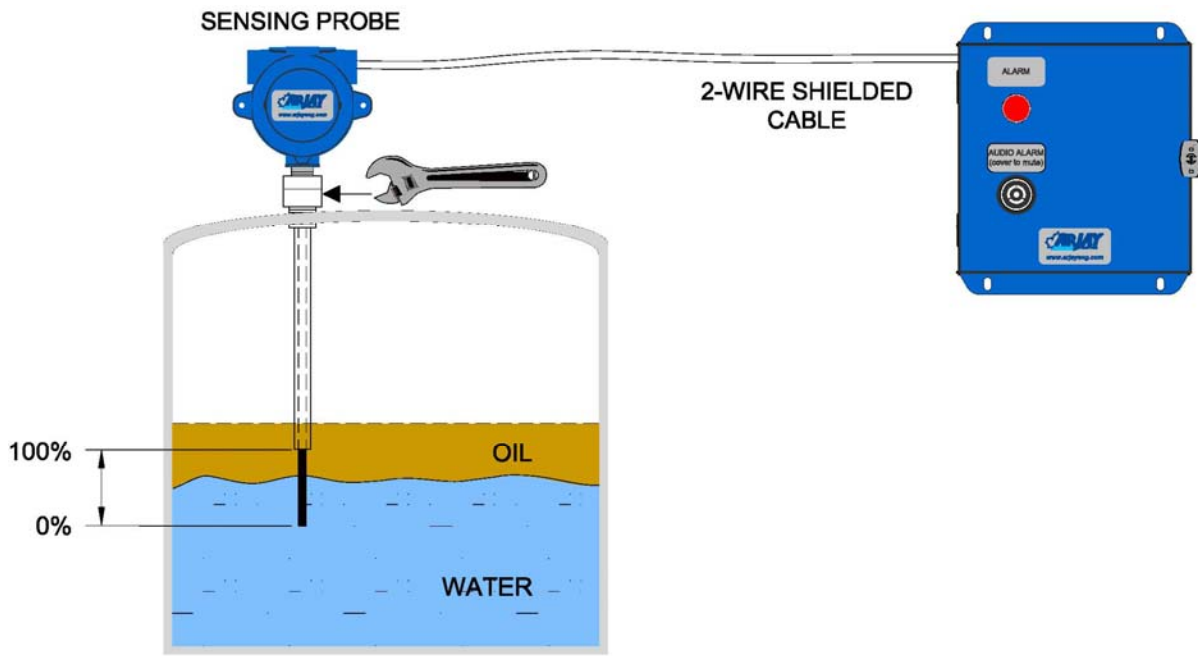

Figure 2 – Typical Installation Vertical

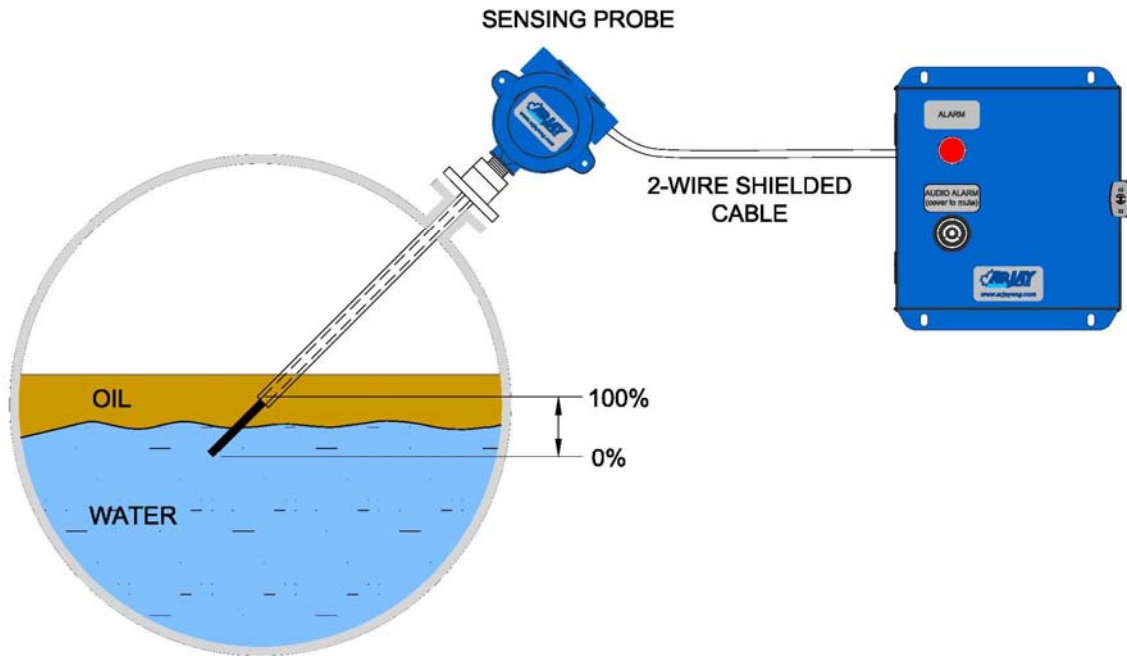

Figure 3 – Typical Installation Angled

2.3 Electrical Installation

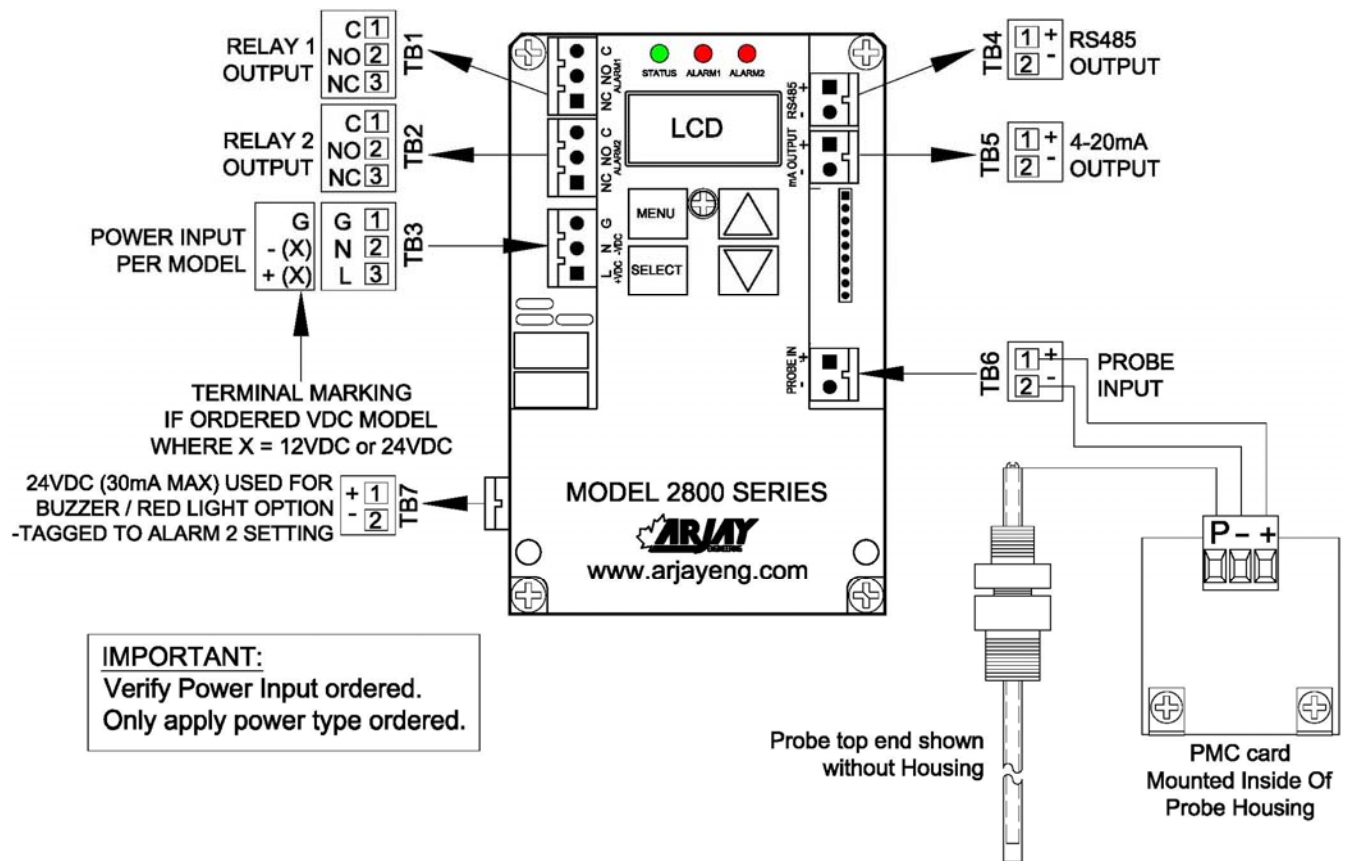

Figure 4 – Electrical Installation Overview

TB1/TB2 - Relay Output

2 SPDT relay, Dry, N.O. Contact 5A @ 250 VAC (Resistive) and N.C. Contact 3A @ 250VAC (Resistive), selectable failsafe or non-failsafe, selectable high or low acting alarm, programmable time delay: 0 – 600 seconds

TB3 - Power Input

Power input as per Model. Check if ordered AC or DC. . Earth ground is connected to G.

TB4 - Network Output

Connect RS485 + and – to the network D+ and D-.

TB5 – 4-20 mA Output (+ and -)

The 4-20mA is a sourced output referenced to Ground. It is not loop powered.

TB6 - Probe Input

Connect '+' to '+', '-' to '-' between the controller and the PMC card. Check polarity to avoid damage.

TB7 – Buzzer / Red Pilot Light Output (Optional)

The connection will be factory wired if ordered.

2.3.1 Input / Output Terminal Specification

Input Terminals – Power Source					
Terminal ID	Overvoltage category	Rated Voltage (V)	Rated Current/power (A/W/VA)	___ HZ or DC	Specified Mains fluctuation
TB3	II	100-240V	150mA	50/60Hz	± 10%
TB3	II	12 OR 24V	250mA	DC	+15% -10%







Input Terminals – Measuring Circuits					
Terminal ID	Function	Measurement Category	Nominal a.c. or d.c line to neutral voltage / if CAT I, Max. transient overvoltage Ut	Nominal a.c. or d.c current	Rating of insulation required for external circuit
TB6	Frequency	I	15V, 50mA / 0	--	DI * or RI**
TB4	RS485 Communication	I	5V, 5mA / 0	--	DI * or RI**

* Double Insulation

**Reinforced Insulation

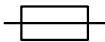
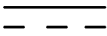
Output Terminals					
Terminal ID	Function	Isolation or protection	Rated V, A	Max. V, A	Load type and nominal
TB1	Load	Relay	N.O. Contact 5A @250VAC & N.C. Contact 3A @250VAC	--	--
TB2	Load	Relay	N.O. Contact 5A @250VAC & N.C. Contact 3A @250VAC	--	--
TB5	Current	Isolator(optional)	- 18V, 20mA, 900Ω - 9V, 20mA, 450Ω	50mA @18V	--
TB7	Voltage	None	24VDC, 30mA	--	Buzzer / Pilot Light

2.4 Glossary of Symbols

	Attention, consult accompanying documents Attention, veuillez consulter les documents ci-joints.		
	Protective Earth Terre de protection		Fuse Coupe-circuit; fusible
	Direct Current (DC) Courant continu		Normally open relay contacts Contacts travail
	Normally closed relay contacts Contacts Repos		Power off Arrô (mise hors tension)
	Power on Marche (mise sous tension)	L	Live Sous tension
N	Neutral Neutre	G	Ground Terre

3.0 STARTUP AND CALIBRATION

3.1 Startup

Check that the power wiring, PMC wiring and probe are wired in accordance with the electrical installation drawing.

Power On the unit. Allow a 1 hour warm-up period before calibrating.

The Status LED on the controller circuit board should be green. A red Status LED indicates a fault condition. If red, check the Troubleshooting section.

The LCD will scroll to the normal operating display. See section 7.0 Menu Flow Chart.

An instrument setup and field calibration is required on initial power up. See section 3.3 for controller setup and section 3.4 to calibrate the transmitter.

3.2 Menu Flow Chart Background Information

The control setup, diagnostics, and calibration are accessed using the display and keypad on the controller. The Flow Chart in Section 7.0 provides an overview to the various menus and features. Keep a copy of the flow chart at hand when accessing the internal controller features.

Below is a description of the menu functions.

3.2.1 Menu Description

Since the 2850 controller has a small LCD, some menu descriptions may be in short form. The following are the menu descriptions:

<i>Diags:</i>	<i>Diagnostics</i>	<i>SENSTVTY:</i>	<i>Sensitivity</i>
<i>Cal Pts:</i>	<i>Calibration points</i>	<i>A1:</i>	<i>Alarm relay 1</i>
<i>Auto Cal:</i>	<i>Auto calibrate</i>	<i>A2:</i>	<i>Alarm relay 2</i>
<i>Man Cal:</i>	<i>Manual calibrate</i>	<i>Alrm:</i>	<i>Alarm</i>
<i>Cal Ok:</i>	<i>Calibrate ok</i>	<i>Alrm Lvl:</i>	<i>Alarm level</i>
<i>Cal Err:</i>	<i>Calibrate err</i>	<i>Diff Hi:</i>	<i>Differential Hi alarm set value</i>
<i>mA out:</i>	<i>mA output</i>	<i>Diff Lo:</i>	<i>Differential Lo alarm set value</i>
<i>mA Span:</i>	<i>mA output span</i>	<i>Alrm Del:</i>	<i>Alarm Delay</i>
<i>Sec:</i>	<i>Seconds</i>	<i>^SP:</i>	<i>Relay Setpoint Hi action</i>
<i>ALRM CAL:</i>	<i>Alarm Calibration</i>	<i>vSP:</i>	<i>Relay Setpoint Low action</i>
<i>Cal:</i>	<i>Calibration point</i>		

3.2.2 Menu Flow Chart

The 2850-OWI controller will display a **% Level** value in its normal operating condition.

The 2850 controller has a password protect feature. The default password is 2000.

For calibration purposes, 0% will be considered as 0% water (100% oil) and 100% will be considered as 100% water (0% oil). When determining your % interface values for calibration, consider this in your calculation.

From the main menu, you can select **Cal Only, View, and Change**.

Cal Only allows a two point calibration only. A password is required to enter this menu item and is described in the calibration section. Output parameters and other control features cannot be accessed through this menu. It is recommend to use this menu if only a re-calibration is to be done.

View allows an operator to view the **Calibration** setpoints in pF, the **Alarms** settings (2852 only) such as low or high action, failsafe or non-failsafe and the 0-600 second delay, the

Diagnostics of raw readings and the **Setup** values such as mA output and ID address. This can be viewed without a password and without risk of changing any values. This information may be requested during technical assistance inquiries.

Change is password protected and allows an operator to enter or change the configuration set-up values indicated in the View. Changes will be required for the initial setup of relay setpoints, delays, span etc. or to re-set the values to the factory default.

3.2.3 Data Entry

Data Entry

Press <▲> / <▼> key to increase / decrease the digital value.

Press <SELECT> key to move the cursor.

Press <MENU> key to abort certain screens

3.3 2850 Controller Setup

Power up the 2850 Controller. The status LED should be green. The LCD should go to the normal operating screen after a series of the following screens (each display for 2 sec.):

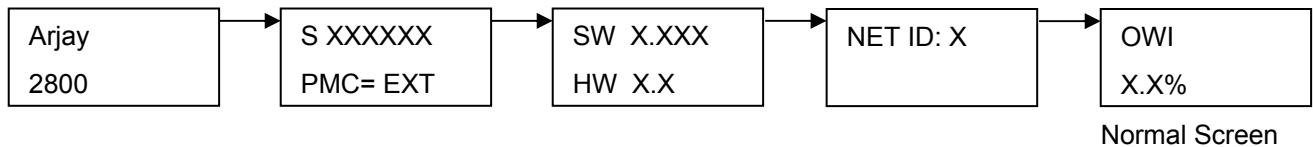

The PMC card has three personalized values that must be entered into the controller. These are factory entered at time of shipment but should be verified prior to calibration or any time a PMC card is changed out.

3.3.1 Setup Menu

Press and Hold the menu key to enter the main menu. Follow the Flow Chart procedure to access the **Change** menu. Toggle to access the Setup menu.

The 2850 Controller has the following setup parameters. These must be set up to the requirements of the application and can be accessed in the CHANGE menu. Follow through the flowchart in section 6.0 and input the settings as required.

1. mA Output Span

The mA output span may be set anywhere within the measurement range. Typically, the mA Span is set at the 100% interface level, but this span value can be changed to any required % level.

2. mA Output

For Direct mA output: 4mA = 0% Water / 100% Oil and 20mA = 100% Water / 0% Oil
For Inverse mA output, 0% level = 20 mA; span level = 4 mA.

3. mA Type

The output can be set for 4-20mA or 0-20mA. The unit is shipped as 4-20mA.

4. PMC

The PMC card has three personalized values that must be entered into the controller. These are factory entered at time of shipment but should be verified prior to calibration or any time a PMC card is changed out. The three PMC values are indicated as A,K & C and are labeled on the PMC card installed at the probe.

5. Defaults

Factory settings are pre-configured into the unit based on the most typical set-up required for this application. This provides for a quick and easy calibration at site but can be changed to suit specific applications. If the setup has been field changed, selecting this will change back to the factory defaults.

6. NET ID

The ID number is used only for network applications. To communicate on a network, each controller must have a unique ID number.

Important: if multiple units on a network have the same address, network errors will result.

7. Filter

Data filtering is used to smooth data from a sudden change and minimize fluctuating readings. For example, a 5 second setting means the calculated value of the capacitance and resulting values of pF will start to respond immediately but will take 5 seconds to reach their final values. The factory default is 0 to provide an immediate and active response. This can be user selected from 0 - 99.9 seconds.

3.3.2 Alarm Menu

The 2852 Controller has 2 relays (A1 and A2) that allow 4 parameters per relay plus a time delay value, which is common to all relays:

1. HIGH ALARM (Diff Hi) POINT. This value is specified in % level. Above this value, relay action is taken depending on the Relay Action and Failsafe settings. Factory default is 40% for A1 and 80% for A2.
2. LOW ALARM (Diff Lo) POINT. This value should be less than the High control point. Below this value, relay action is taken depending on the Relay Action and Failsafe settings. Factory Default is 20% for A1 and 60% for A2.
3. RELAY DELAY. Minimum time in seconds for an alarm to exist before the corresponding relay changes to its alarm state. The relay alarm state depends on the Relay Action and Failsafe settings. Factory default is 0. This can be user selected from 0 – 600 seconds.
4. RELAY ACTION. High or Low Action. For high action, the alarm is activated when the % level rises above the high alarm set point and is reset when the % level drops below the low alarm set point. For low action, the alarm is activated when the % level drops below the low alarm set point and is reset when % level rises above the high alarm set point. Factory default is HIGH action.
5. FAILSAFE. Failsafe typically means that the relay is normally (when not in an alarm condition) held in an energized state. In an alarm condition, the relay is de-energized i.e. identical to when the instrument power is shut off. The rationale is that the alarm condition should match the Power Fail condition. Factory default is Yes.

The following table shows the effect of the Relay Action and Failsafe settings.

Relay Action	Failsafe Setting	Effect
High	No	Alarm condition when process level rises above the High Setpoint for at least the alarm delay period. Alarm condition remains active until the process level drops below the Low Setpoint. No action is taken when the process level is between the High and Low Setpoints.

		In the alarm condition, the corresponding alarm LED is turned ON, and the relay is energized.
High	Yes	Alarm condition set and reset as above. In the alarm condition, the corresponding alarm LED is turned ON, but the relay is de-energized.
Low	No	Alarm condition when process level drops below the Low Setpoint for at least the alarm delay period. Alarm condition remains active until the process level rises above the High Setpoint. No action is taken when the process level is between the High and Low Setpoints. In the alarm condition, the corresponding alarm LED is turned ON, and the relay is energized.
Low	Yes	Alarm condition set and reset as above. In the alarm condition, the corresponding alarm LED is turned ON, but the relay is de-energized.

3.4 2850 Controller Calibration

3.4.1 Auto Calibration

As per the Menu Flow Chart in Section 7.0, press and hold Menu key until "Cal only" shows on display. Press <SELECT> key, enter password "2000" and press <SELECT>. If auto calibration is required, press <SELECT>.

1. For the 1st point entry, enter the current interface level value in %. Note: 0% = 0% water and 100% = 100% water. For example an entry of 30% indicates the interface level is at 30% water/70% oil). See section 3.2.3 for value entry description. Confirm the capacitance value in pF is stabilized, press <SELECT> key to accept the 1st point value. The 1st calibration point has been done. The LCD should go to the 2nd point entry menu.
2. Change the interface level in the vessel by a minimum of 10.0%. The interface level may be raised or lowered as long as the interface is along the length of the active probe. A change of less than 10.0% may be used in some applications but is not recommended to ensure calibration accuracy. The capacitance value in pF will increase if raising the interface or decrease if lowering the interface. In some applications where the entrance connection is a flange or extraction fitting, you can simulate an interface change by raising the probe so the interface lowers on the probe. This can only be done if the active portion of the probe is not exposed to air.
3. For the 2nd point entry, enter the new current interface level value in %. For example an entry of 60% indicates the interface level is at 60% water/40% oil)See section 3.2.3 for value entry description. Confirm the capacitance value in pF is stabilized, press <SELECT> key to accept the 2nd point value. The 2nd calibration point has been done.

If the calibration is successful, the display will show "Cal Ok" for a couple of seconds and then return to the calibration menu. If the display shows "Cal Err", then a calibration fault has occurred. Check the following:

1. The 2nd interface % entry value is accidentally left at the 1st calibration point % level.
Re-do the auto calibration according the above steps 1 – 3.
2. The interface in the vessel was not changed from the 1st calibration point.
Re do the auto calibration according the above steps 1 – 3.

3. If 1 or 2 are not the cause, call Arjay Engineering Ltd.: Toll free: (800) 387 – 9487 (North America Only), tel. +1 (905) 829-2418

3.4.2 Manual Calibration

Manual Calibration allows you to override the values that have been set through the automatic calibration. This feature may be used for a number of different reasons. For example.

1. One of the calibration points is desired to be re-calibrated. The user can view the pF reading of the probe in the Diagnostics menu and also record the actual interface level in the vessel at the same time. These values can then be entered in the Manual Calibration to change either Cal Point 1 or Cal Point 2.
2. If a calibration was done using 20% and 60 % as the two values (for example), but it was determined a future date that the 60% should have been entered as 70%.
3. The process level cannot be altered at the time of calibration so a random pF value and % level value is entered as the second point to allow operations until a proper second point can be entered. See method in 1 above.

This completes the calibration procedure for the 2850-OWI Monitor.

4.0 2850 CONTROLLER NETWORK

The 2852 Level Controller may be monitored and calibrated via RS-485 protocol compatible digital communications.

Typical features are:

1. Ease of wiring in multiple level point monitoring:

Up to 255 Model 2852's (or other Arjay 2800 Series level monitors) may be connected together in a daisy chain (2 wire communication plus power wiring) connection to an Arjay Remote Access monitor or customer control system which allows viewing data and setup of any of the transmitters on the network. The 4-20mA output may still be used if necessary.

2. Setup for the 2852 for network operation:

Each 2852 controller must have a unique number to connect in a network system. See section 7.0 Menu Flow Chart, CHANGE menu for details to change the ID number.

4.1 Modbus Configuration

Parameter settings: 9600 Baud Rate; Even Parity, 8 Data Bits and 1 Stop Bit.

Wiring connection: RS485 (+) connect to D+; RS485 (-) connect to D-.

4.2 2800 Series Modbus Register Mapping

REG	Zero Based	DESCRIPTION	TYPE	No. of Reg
40001	0	Serial Number	float	2
40003	2	Hardware Rev / Software Rev	byte	1
40004	3	Sensitivity / Mode	byte	1
40005	4	Instrument Status	int	1
40006	5	Model / Modbus Address	byte	1
40007	6	Relay2 Setup / Relay 1 Setup	byte	1
40008	7	Password	int	1
40009	8	XA "A" cal parameter	float	2
40011	10	XK "K" cal parameter	float	2
40013	12	XC "C" cal parameter	float	2
40015	14	Filter	float	2
40017	16	Slope – pF per % level	float	2
40019	18	Offset – pF for empty vessel	float	2
40021	20	mA output span value	float	2
40023	22	mA output Zero value	float	2
40025	24	mA output Trim Slope value	float	2
40027	26	mA output Trim Offset vlaue	float	2
40029	28	Cal1 PV: 1st calibration point level value in %	float	2
40031	30	Cal2 PV: 2nd calibration point level value in %	float	2
40033	32	Cal1 pF: 1st calibration point capacitance value in pF	float	2
40035	34	Cal2 pF: 2nd calibration point capacitance value in pF	float	2
40037	36	Relay 1 : Differential High Alarm [% Level]. Only used for Linear Level type. Not used for Single Point Alarm application	float	2
40039	38	Relay 2: Differential High Alarm [% Level]. Only used for Linear Level type. Not used for Single Point Alarm application	float	2
40041	40	Relay 1: Differential Low Alarm [% Level] OR Single Point Alarm [pF]. Single Point Cal: used as captured pF during cal	float	2
40043	42	Relay 2: Differential Low Alarm [%Level]. Only used for Linear Level type. Not used for Single Point Alarm application	float	2
40045	44	Relay 1 On delay [in seconds]. Only used for Linear Level or Single Point Alarm application	int	1
40046	45	Relay 2 On delay [in seconds]. Only used for Linear Level type. Not used for Single Point Alarm application	int	1
40047	46	mA Analog Output	float	2
40049	48	Oscillation Frequency	float	2
40051	50	Frequency	float	2
40053	52	Capacitance	float	2
40055	54	Filtered Capacitance	float	2
40057	56	Level	float	2

5.0 MAINTENANCE

There is no routine cleaning required for this controller.

6.0 TROUBLESHOOTING

CONDITION	DO THIS
1. Status LED is OFF and the LCD display is off	Check the power to the unit. If the unit is a 12VDC or 24VDC model, check the external source and polarity is correct. If the unit is a 100-240VAC model, then check the Line, Neutral and Ground wiring is correct.
2. If the status LED is RED	<p>This indicates a major error such as memory failure, no probe signal etc. Check the following:</p> <ul style="list-style-type: none"> • Make sure the PMC is installed • Make sure the PMC wiring is correct and there are no breaks in the wiring. At the controller, measure across the Probe Input terminals with a DC meter. Make sure "Common" lead of meter is on '-' terminal. It should read (+) 8 to (+)10 VDC with the PMC connected and approximately 20 to 24 VDC with the PMC terminal disconnected. • Microprocessor may have lost its parameters due to a surge in the line. Go to Diagnostic Menu (see Flow Chart) to check the Calibration values, frequency and capacitance values Call Arjay Technical Support.
3. No mA output OR incorrect mA output.	<p>IMPORTANT: THE UNIT SOURCES mA OUT FROM THE mA OUTPUT TERMINAL. <u>THIS TERMINAL SHOULD NOT BE CONNECTED TO +24V.</u> IT IS NOT A 2 WIRE mA TRANSMITTER. See Figure 4 for Electrical hookup details.</p> <ul style="list-style-type: none"> • Disconnect external wires from mA output and measure with mA Meter. • Check the mA output Action (direct or inverse) and mA output Span are set as desired. See section 7.0 Flow chart / Change menu. • If the mA output still does not match the level, then call Arjay Technical Support.

ARJAY ENGINEERING TECHNICAL SUPPORT

(800) 387-9487

+1 (905) 829-2418

www.arjayeng.com

7.0 FLOW CHARTS

NORMAL OPERATING DISPLAY

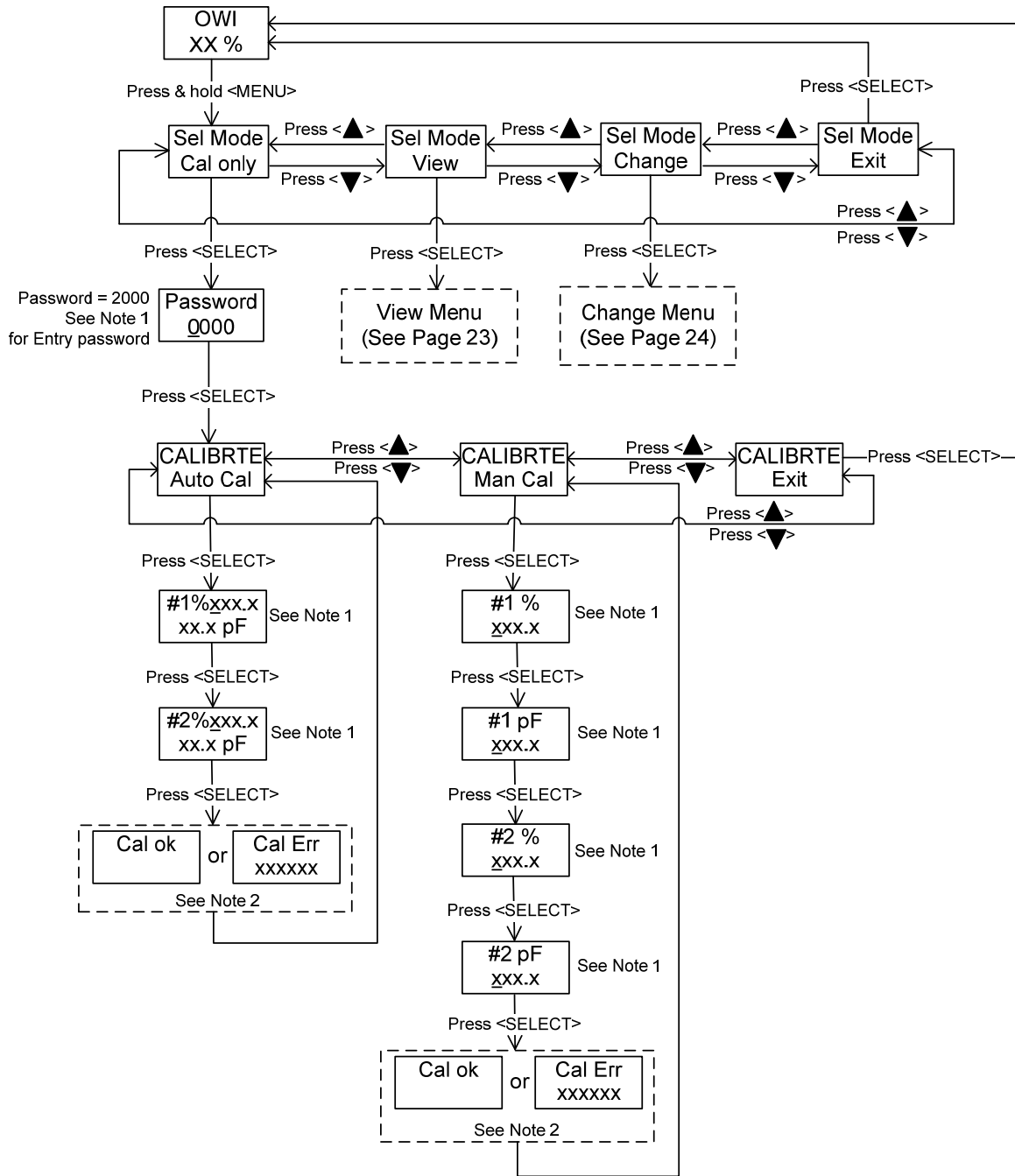

Note 1: Data Entry

_ : Flash cursor indicates to enter the value

Press <▲> / <▼> key to increase / decrease the digital value.

Press <SELECT> key to move the cursor.

Note 2: Calibration information, it only shows about 2 seconds

VIEW MENU

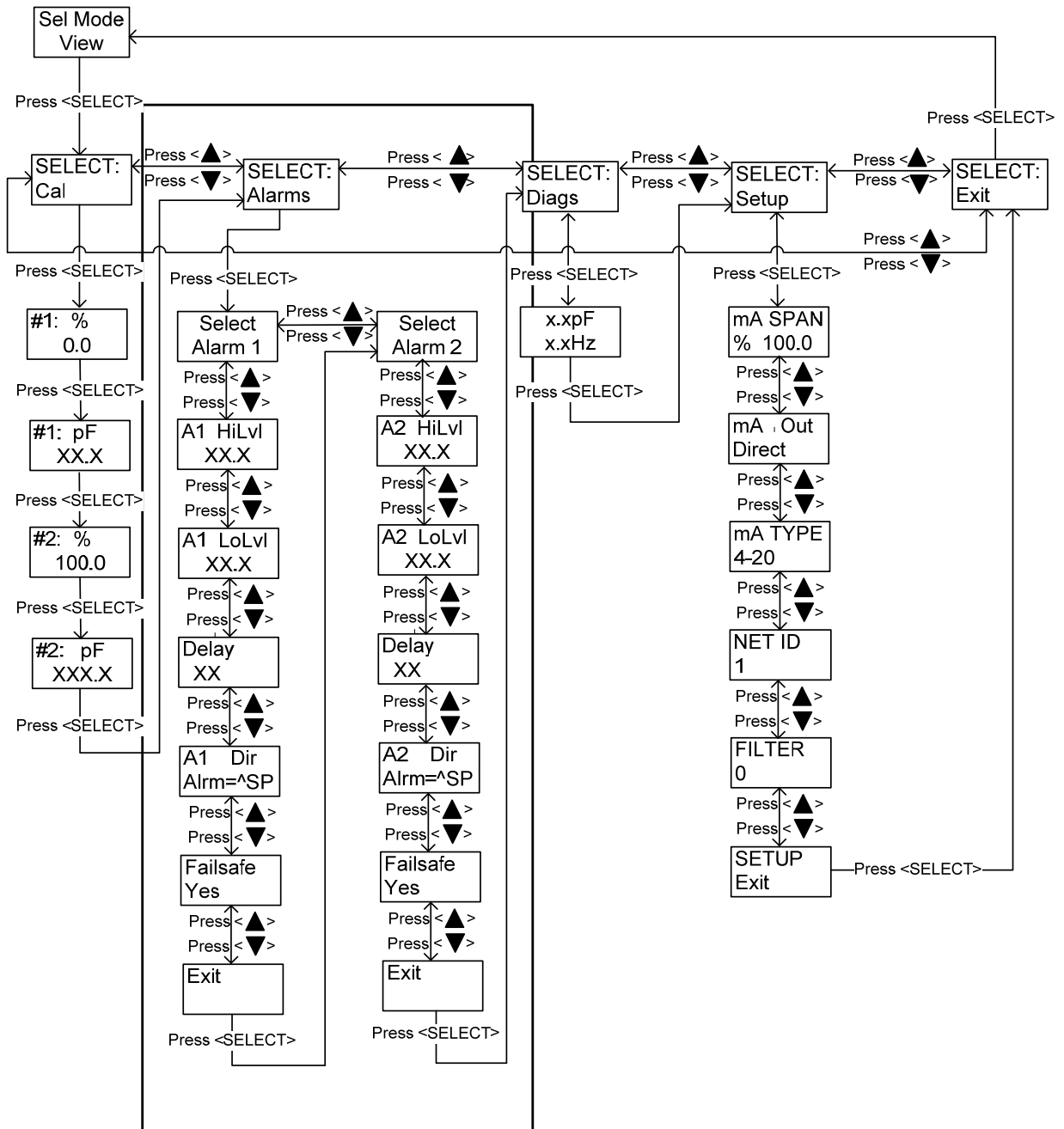

CHANGE MENU

