



MODELS:
2852-LT / 2851-LT
REMOTE MOUNTED
LEVEL MONITOR



USER MANUAL (REV: 3.5)

ARJAY ENGINEERING LTD.		
2851 Brighton Road Oakville (Toronto), Canada L6H 6C9	TEL: ++1 (905) 829-2418 FAX: ++1 (905) 829-4701 NORTH AMERICA: 1-800-387-9487	WEBSITE: www.arjayeng.com EMAIL: arjay@arjayeng.com

THIS PAGE INTENTIONALLY LEFT BLANK

TABLE OF CONTENT

NOTICE

Please read the Installation Notes (4.0) prior to locating and mounting the instrument.

1.0	SPECIFICATION	4
2.0	USE HAZARD INFORMATION.....	7
3.0	INSTRUMENT OVERVIEW.....	8
3.1	Features	9
3.2	Model Number Table	9
4.0	INSTALLATION.....	10
4.1	Remote Mounted Controller Installation	10
4.2	Probe Installation.....	11
5.0	CONTROLLER OVERVIEW.....	13
5.1	Input / Output Terminal Specification	14
5.2	Permanent Power Connection (AC Powered Models Only).....	15
5.3	Glossary Of Symbols.....	15
6.0	STARTUP AND CALIBRATION.....	16
6.1	Startup.....	16
6.2	Menu Flow Chart Background Information	16
6.2.1	Menu Short Form.....	16
6.2.2	Menu Description.....	17
6.2.3	Data Entry.....	17
6.3	285X Controller Setup	17
6.3.1	Setup And Network.....	17
6.3.2	Relay Setup Menu	18
6.4	285X Controller Calibration	20
6.4.1	Auto Calibration	20
6.4.2	Manual Calibration.....	20
7.0	CONTROLLER NETWORK.....	21
7.1	MODBUS Configuration	21
7.2	2800 Series MODBUS Register Mapping	22
8.0	MAINTENANCE.....	23
9.0	TROUBLESHOOTING.....	24
10.0	FLOW CHARTS.....	26

TABLE OF FIGURES

FIGURE 1 – TYPICAL INSTALLATION.....	8
FIGURE 2 – PROBE INSTALLATION.....	12
FIGURE 3 – CONTROLLER OVERVIEW.....	13

1.0 SPECIFICATION

Specifications are subject to change without notice

Specification	Details
Power Input: <i>(Specify voltage at time of Order)</i>	12VDC +15% /-10% or 24VDC +15% /-10%, 250mA maximum 100VAC – 240VAC +/- 10%, 50/60 Hz, 150mA maximum Note: DC input models must be supplied by Limited Energy power source. Limited Energy means compliance with one of the following requirements: <ul style="list-style-type: none"> - Class 2 circuit according to Canadian Electrical Code, Part, I, C22.1; - Class 2 circuit according to National Electrical Code, NFPA-70; - Limited Power Supply (LPS) according to IEC 60950-1; - Limited-energy circuit according to IEC 61010-1.
Connections to mains supply	Permanent (for AC/DC model)
User Interface: Display & Keypad Communication Interface:	Two line LCD display, Alarm status LEDs and Keypad for select menu or enter values Modbus (RS485)
Relays / Analog Outputs: Relay Outputs mA Signal Output	2 SPDT relays, Dry Contacts are 3A @ 250 VAC (Resistive), selectable failsafe or non-failsafe, selectable high or low acting alarm, programmable time delay: 0 – 600 seconds , 0-100% differential (2851: Isolated)** 4-20 mA, 900 Ohms max (24VDC Power) OR 450 Ohms max (12VDC Power). ** Optional (Note: If Isolation is ordered then relays are not available)
Instrument Performance: Measuring Range Accuracy Resolution Calibration	0 - 5000 pF (Most applications are 100pF to 1000pF) 0.2% of full scale pF 0.004% at 1000pF Linear 2 point Auto calibration or Manual calibration
Environmental: Operating conditions Ambient Temperature Process Temperature Maximum Process Pressure Relative humidity Altitude	Continuous -20 °C to +55 °C controller -40 °C to +55 °C PMC2800 pulse card in probe junction box -60 °C to +200 °C Standard or Heavy Duty Teflon Probe -60 °C to +100 °C Flexible Tefzel Probe 1500 PSI / 10342 kPa 0 to 95% (non-condensing) ≤2000 m

Specification	Details
Installation Category	II
Pollution Degree	2
Equipment mobility	Fixed
Mechanical Specification:	Refer to Dimensional Drawing
Protection Degree – Controller Enclosure	Type 4 / IP65 Painted Steel (Blue) Type 4x / IP66 Polycarbonate (Gray) Type 4x / IP66 316 Stainless Steel
Protection Degree – Probe Junction Box	IP65
Options on Controller Enclosure:	Buzzer Pilot Light OR Strobe/Beacon Intrinsic Safety Barrier Custom alarms
2800 Series Controller Certification	
Ordinary Locations:	<ul style="list-style-type: none"> • UL file number: E343390 • UL / IEC 61010-1, 2nd Edition, 2008/10/28 (Electrical Equipment for Measurement, Control, and Laboratory Use; Part 1: General Requirements) • CAN/CSA-22.2 No. 61010-1, 2nd Edition, 2008/10/01, (Electrical Equipment for Measurement, Control, and Laboratory Use; Part 1: General Requirements) • CE: UL / IEC 61010-1; IEC / EN 61000-4; ISO 9001:2008
Remote Level Probe Certification (Hazardous Locations)	
<i>North America</i>	<ul style="list-style-type: none"> • CSA file number: 56812 • Class – 2258-02 – Process control equipment for Hazardous Locations • Class – 2258-82 – Process control equipment for Hazardous Locations – Certified to US Standards • Ex db IIC T5 Gb • Class I, Zone 1, AEx db IIC T5 Gb
<i>International IECEx/ATEX *</i>	<ul style="list-style-type: none"> • II 2G Ex db IIC T5 Gb • Sira 17ATEX1303X • IECEx CSA 17.0034X
<u>Optional Intrinsic Safety *</u> (Zone 0, Div 1) for North America, IECEx/ATEX	For certifications see PMC2800/PMC2800-TMP manual (Addendum 1) for more detail. Note: Must order Intrinsic Safety Barrier. Model: 28aaa-bbb-c-defg

*** For ATEX / IECEx / CSA / UL and EU Declaration of Conformity certificates refer to www.arjayeng.com**

SPECIFIC CONDITIONS OF USE FOR HAZARDOUS LOCATION
(denoted by X after the certificate number)

1. Process temperature for the standard and heavy duty probes are -60°C to +200°C and for flexible probe is -60°C to +100°C. It is end-user's responsibility to ensure that the ambient around the Capacitance Controller and ARJAY Probe does not exceed the permitted ambient of +55°C.
2. The maximum process pressure is 1500psi/ 10342KPa.
3. Only approved certified entry devices shall be used.
4. Flameproof joints are not permitted to be repaired in the field. If the flamepath is damaged, the enclosure is to be removed from service and replaced with a new enclosure.



Model: 28aaa-bbb-c-defg

Where:

aaa	bbb	c	d	e	f	g
51 *	LT *	1 = 100-240VAC, 50/60Hz	0 = No Housing	0 = No Light	0 = No Buzzer	0 = No Intrinsic Barrier
52	LS	2 = N/A	1 = Painted Steel blue (4)	1 = Red Pilot Light	1 = Buzzer	1 = Intrinsic Barrier
	OWS	3 = 12 VDC	2 = Polycarbonate (4X)	2 = Amber Beacon		
	OWI *	4 = 24 VDC	3 = Brushed 316SS (4X)	9 = other		
	CAP *					
	FCM *					
	FCS					
	IFA					
	ILA					

** 2851 available for these models only.*

2.0 USE HAZARD INFORMATION

 CAUTION	Indicates a potentially hazardous situation that may result in minor or moderate injury.
 WARNING	Indicates a potentially or imminently hazardous situation which, if not avoided, could result in death or serious injury.
 DANGER	Indicates a potentially or imminently hazardous situation which, if not avoided, will result in death or serious injury.
NOTICE	Indicates a situation which, if not avoided, may cause damage to the instrument. Information that requires special emphasis.

3.0 INSTRUMENT OVERVIEW

The Arjay Model 2852-LT & 2851-LT Level Monitor provides a proportional analog output. The 2852-LT includes two independent alarm relays for monitoring and control of liquids or solids in a tank or vessel. The Model 2851-LT provides a single isolated analog output without relays. The designations 2852 & 2851 will be used interchangeably throughout this manual with 285X.

The Arjay system has an active capacitance probe that is inserted into the vessel. As the material level changes around the probe, the capacitance reading of the probe increases or decreases. The controller output and relays are calibrated at user determined levels of product on the probe.

The remote mounted Arjay 285X controller monitors the capacitance change of the probe and activates the relay contacts for use with alarms, pumps, valves, etc. The analog output and RS-485 Modbus communication are available for control interface.

The complete 285X-LT Series system consists of the probe, the PMC card and 2852 controller. The standard probe is constructed of a Teflon coated probe. The probe length is customer specified for the tank and depth of material to be measured. Probes can be inserted vertically or angled into the tank. The importance is that the probe must be parallel to the tank wall when inserted for best linearity. A concentric shielded probe is available as an option to improve linearity and achieve a parallel ground reference. The PMC card is mounted in a junction box at the top of the probe. The PMC card translates the capacitance signal from the probe into a frequency pulse, which can be transmitted up to one kilometer to the 2852 controller via 2-wire shielded cable.

Calibration requires a known change of level in the vessel to provide two calibration points. The Arjay processor will automatically extrapolate to determine the 0 to 100% span.

The two relays (Model 2852-LT only) can alarm at different levels and are entered as a % value through the keypad and display. Each relay also has a differential setpoint to allow the relay to activate at one level and de-activate at a different level. This is similar to a latching format which can cycle a pump or level between two points through the use of only one relay.

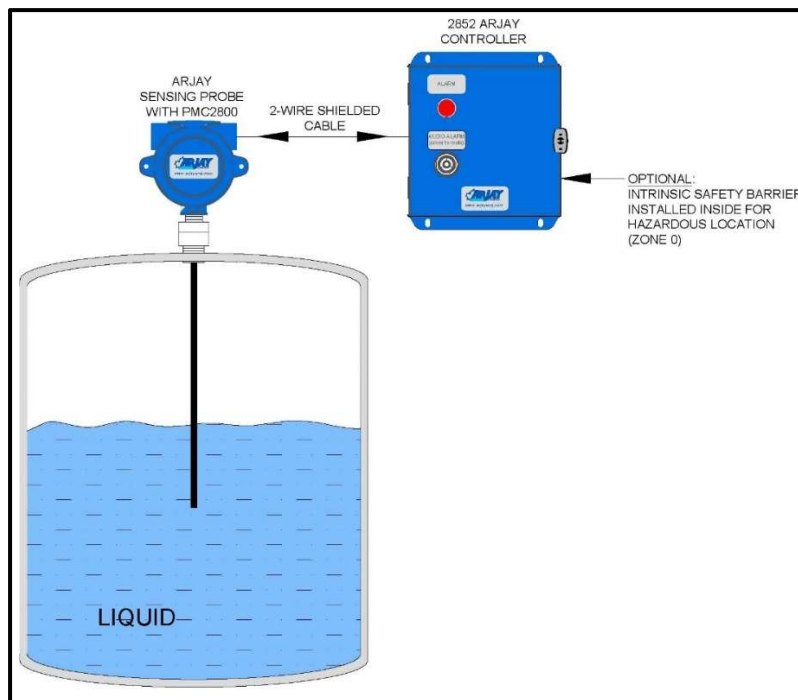

Figure 1 – Typical Installation

3.1 Features



- Microprocessor based RF capacitance level transmitter
- Two Differential Alarm relays (SPDT, 3A @ 250VAC) - Model 2852-LT only
- 0-20mA or 4-20mA field selectable output
- Modbus protocol via RS-485 for access by Arjay handheld, Central Access Panel or compatible system
- Local 2 point Auto or Manual calibration or remote calibration via network
- User specified custom features may be added by contacting Arjay Engineering Ltd.

3.2 Model Number Table

MODEL	DESCRIPTION
2851-LT	REMOTE MOUNTED 4-20mA (ISOLATED)
2852-LT	REMOTE MOUNTED 4-20mA (NON-ISOLATED) C/W 2 ALARM RELAYS
<i>* The designation 2852 & 2851 will be interchangeable with 285X throughout this manual.</i>	

4.0 INSTALLATION

NOTICE	If any damage to the instrument is found, please notify an Arjay Engineering representative as soon as possible prior to installation.
NOTICE	Qualified Personnel must undertake all installations.

 WARNING	EXPLOSION HAZARD – DO NOT OPEN PROBE JUNCTION BOX WHEN ENERGIZED.
 WARNING	DO NOT OPEN WHEN EXPLOSIVE ATMOSPHERE IS PRESENT

 WARNING	If the equipment is used in a manner not specified by the manufacturer, the protection provided by the equipment may be impaired.
--	---

4.1 Remote Mounted Controller Installation

Choose the mounting location in accordance with good instrument practice. Extremes of ambient temperature and vibration should be avoided (see specifications and installation drawing).

The 285X controller may be mounted up to one kilometer from the PMC card using a minimum 18 gauge, 2-wire SHIELDED cable (Belden 8760 or Equivalent).

Check the polarity of the + and - wiring between the controller and the PMC prior to powering on the unit; + to + and - to - to avoid damage. Shield of cable should be connected to secondary ground terminal marked as \perp (at controller side only). Incoming Earth ground should be connected to primary ground terminal marked \oplus on sub plate.

NOTICE	<p style="text-align: center;">The controller operates in a Failsafe Mode (factory default)</p> <p><i>This means that the relays are in an energized state during normal operation. The N.O. relay contact will be held closed and the N.C. relay contact will be held open during a normal condition. This will allow the relay to return to its non-energized (shelf) state during an alarm, fault or power failure condition. Wire accordingly.</i></p>
---------------	---

NOTICE	Maximum Conduit size for installation size is 3/4" FNPT.
---------------	--

NOTICE	To ensure proper operation and electrical safety, make sure the 285X enclosure and the PMC junction box are electrically grounded.
---------------	--

 CAUTION	<p>The <u>Internal</u> ground screw provided in this enclosure must be used for equipment grounding connection.</p> <p>The <u>External</u> ground screw is provided for use only as a supplemental connection where required (or, permitted) by local codes or authorities.</p>
--	---

4.2 Probe Installation

NOTICE

Read the following information ***before*** installation.

Standard probe entry into a tank is via a 3/4" NPT opening (standard probes) or 1" NPT opening (heavy duty probes). Flanges and concentric shields are available as options. The entrance configuration may vary depending on the application requirements.

TO SCREW IN THE PROBE (THREADED ENTRY) USE A WRENCH ON THE LOWER FITTING ONLY. The probe fittings are compression type with Teflon ferrules assembled by applying torque between the two sections. The fittings are sealed at the factory to provide a compression seal capable of withstanding pressure up to 1500 psi / 10342kPa. Once opened they cannot be reassembled without new ferrules.

The probe should be mounted vertically and parallel to a reference ground surface, which is typically the vertical wall of the tank or a concentric shield around the probe. The following points are important when installing the probe:

- 1- **Reference ground:** This is important for accurate measurements and is typically the metal walls of the tank. For non-metallic tanks, a concentrically shielded probe is required in which case the shield provides its own Ground. **IMPORTANT:** For standard threaded entry and flange entry probes (without concentric shields), make sure the fittings are clean to ensure a **GOOD ELECTRICAL CONNECTION BETWEEN THE PROBE HEAD ENCLOSURE AND THE TANK (REFERENCE GROUND)**.
- 2- **The distance between the probe and the ground reference:** This only applies to probes without concentric shields. The closer the distance to the tank wall, the greater the sensitivity of measurement; too close and bridging problems may occur with more viscous material. The distance should be greater than 25mm.
- 3- **The degree of parallelism between the probe and the reference ground:** The probe must be parallel to the reference ground for a linear output signal. Note: the concentric shield option is inherently linear due to the concentric shield.
- 4- **The measurement accuracy may be affected by the temperature change of the material in the tank.** The amount of measurement error depends on the material. If the temperature change is excessive, temperature correction may be required. Contact the Arjay representative for more information.
- 5- **Agitators or moving objects in the tank:** Moving objects in the tank close to the probe such as agitator blades, moving baffles etc. appear as moving ground references to a capacitance probe and will cause measurement errors. In applications where these objects are present, a concentrically shielded probe should be used.

NOTICE

Install the probe with care. Teflon sheath is used to electrically isolate the metal probe from the liquid. Damage causing leaks may cause reading errors.

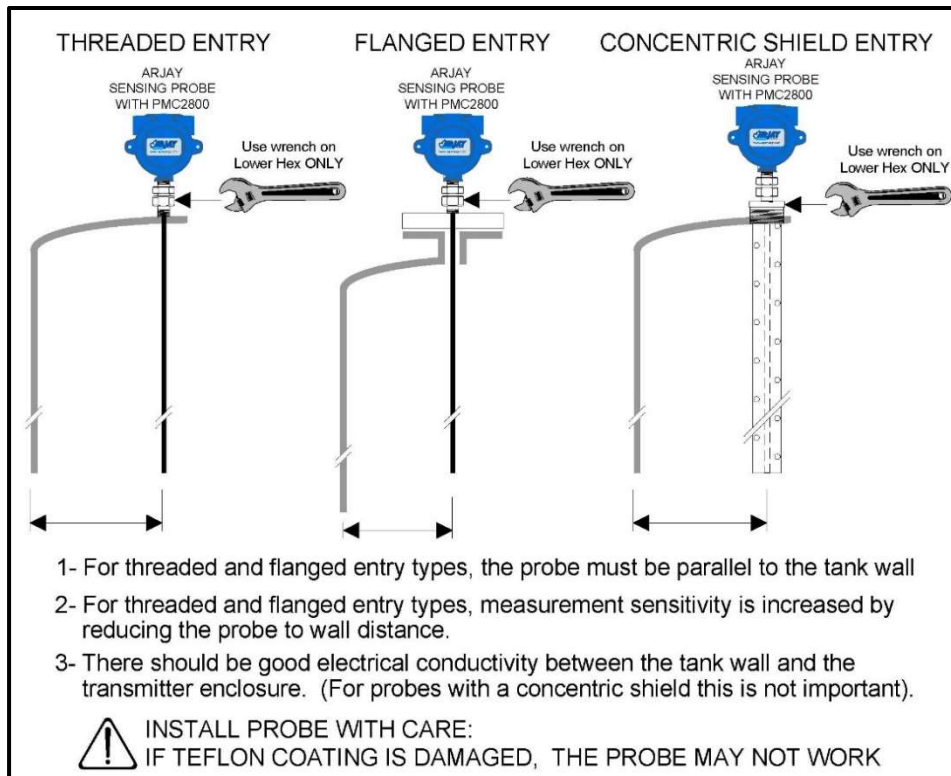

Figure 2 – Probe Installation

5.0 CONTROLLER OVERVIEW

See specific drawing(s) attached to this manual for more detail

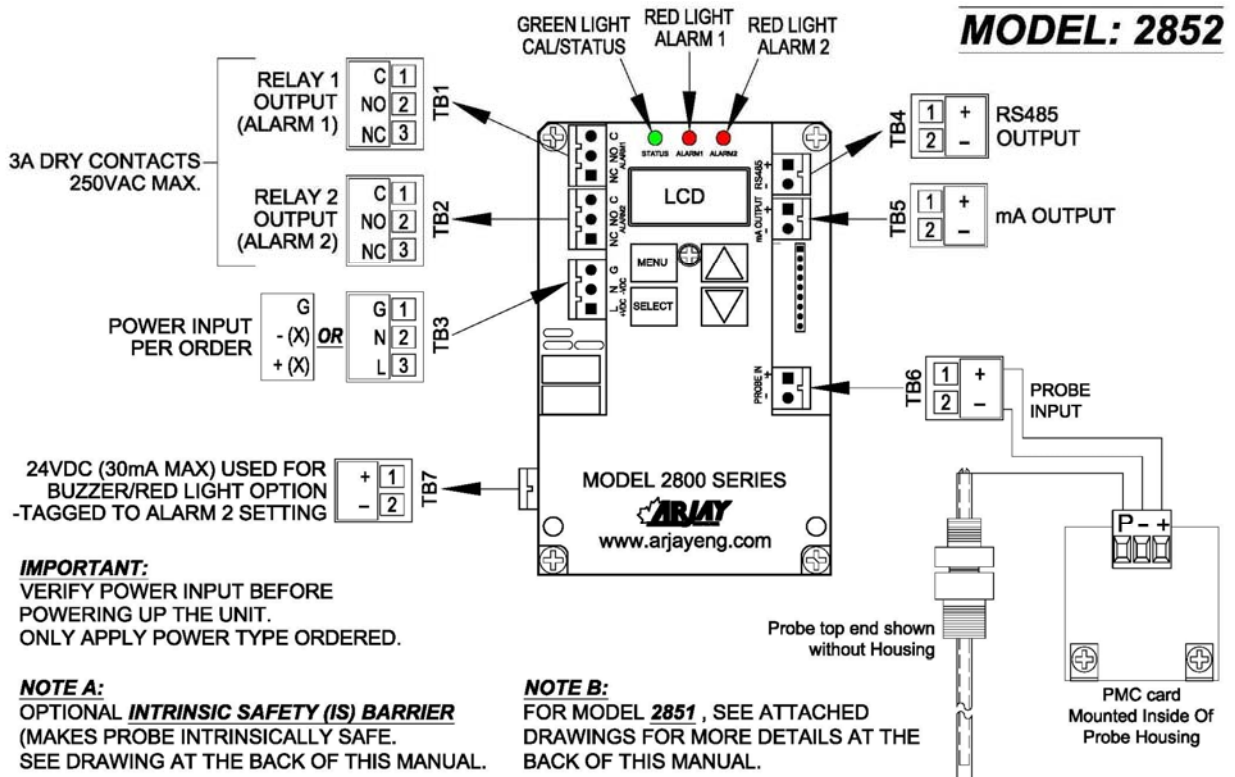

Figure 3 – CONTROLLER OVERVIEW

TB1/TB2 - Relay Output (Model 2852 only)

2 SPDT relay, Dry Contacts are 3A @ 250 VAC (Resistive), selectable failsafe or non-failsafe, selectable high or low acting alarm, programmable time delay: 0 – 600 seconds, 0-100% differential.

NOTICE

The controller relays are factory set in a Failsafe mode.

TB3 - Power Input

Power input as per Model. Check if ordered AC or DC. Earth ground is connected to Primary ground screw inside of enclosure.

TB4 - Network Output

Connect RS485 + and – to the network D+ and D-.

TB5 - mA Output (Optional Isolator for Model 2851)

The 4-20mA is a sourced output referenced to Ground. It is not loop powered.

TB6 - Probe Input

Probe input is wired by the factory. The terminal block is disconnected during shipment for static reasons and has to be re-connected during installation. TB6 has two “+” connections. Either is acceptable.

TB7 – Buzzer / Red Pilot Light Output (Optional)

The connection will be factory wired if ordered.

5.1 Input / Output Terminal Specification

Input Terminals – Power Source					
Terminal ID	Overvoltage category	Rated Voltage (V)	Rated Current/power (A/W/VA)	— HZ or DC	Specified Mains fluctuation
TB3	II	100-240V	150mA	50/60Hz	± 10%
TB3	II	12 OR 24V	250mA	DC	+15% -10%

Input Terminals – Measuring Circuits					
Terminal ID	Function	Measurement Category	Nominal a.c. or d.c line to neutral voltage / if CAT I, Max. transient overvoltage Ut	Nominal a.c. or d.c current	Rating of insulation required for external circuit
TB6	Frequency	I	N/A	--	DI * or RI**
TB4	RS485 Communication	I	5V, 5mA / 0	--	DI * or RI**

* Double Insulation

**Reinforced Insulation

Output Terminals					
Terminal ID	Function	Isolation or protection	Rated V, A	Max. V, A	Load type and nominal
TB1	Load	Relay	3A Contact @250VAC	--	--
TB2	Load	Relay	3A Contact @250VAC	--	--
TB5	Current	Isolator(optional)	- 18V, 20mA, 900Ω - 9V, 20mA, 450Ω	50mA@18V	--
TB7	Voltage	None	24VDC, 30mA	--	Buzzer / Pilot Light

5.2 Permanent Power Connection (AC Powered Models Only)

- 1) Connection to the building wiring system shall be in accordance with the Canadian Electrical Code (CEC), Part 1 in Canada, the National Electrical Code, ANSI/NFPA 70 in the USA, or the local electrical codes of the country where the equipment is being installed.
- 2) A disconnecting device is required. The disconnecting means shall disconnect all current-carrying conductors.
- 3) 15A circuit breaker or equivalent fuse is required.
- 4) An external switch or breaker shall be in close proximity to the equipment and within easy reach of the operator. The switch shall be marked as the disconnecting device for the equipment and include the symbols to its "ON" and "OFF" positions using the following symbols:



- 5) The wiring for AC power should be minimum 18 AWG / 300V or as required by local / country codes.
- 6) After field wiring, the primary wires must be secured to the enclosure by tie-wraps to maintain the separation from the signal wires.
- 7) Wiring diagram for permanent connection: See drawings at the back of this manual.
- 8) Use copper conductors only.

5.3 Glossary Of Symbols

	Attention, consult accompanying documents <i>Attention, veuillez consulter les documents ci-joints.</i>	
	Primary Protective Earth Ground <i>Primaire de terre de protection</i>	
	Secondary Earth Ground <i>Mise à la terre de secondaire</i>	
	Direct Current (DC) <i>Courant continu</i>	
	Normally closed relay contacts <i>Contacts Repos</i>	L
	Power on <i>Marche (mise sous tension)</i>	G
		N
		Live <i>Sous tension</i>
		Ground <i>Terre</i>
		Fuse <i>Coupe-circuit; fusible</i>
		Normally open relay contacts <i>Contacts travail</i>
		Power off <i>Arrêt (mise hors tension)</i>
		Neutral <i>Neutre</i>

6.0 STARTUP AND CALIBRATION

6.1 Startup

Check that the power wiring, PMC wiring and probe are wired in accordance with the electrical installation drawing. Connect the probe terminal block TB6 as per figure 3.

Power On the unit. Allow a 1 hour warm-up period before calibrating.

The Status LED on the controller circuit board should be green. A red Status LED indicates a fault condition. If red, check the Troubleshooting section.

The LCD will scroll to the normal operating display. See section 10.0 Menu Flow Chart.

NOTICE

An instrument setup and field calibration is required on initial power up. See section 6.3 for controller setup and section 6.4 to calibrate the transmitter.

6.2 Menu Flow Chart Background Information

The control setup, diagnostics, and calibration are accessed using the display and keypad on the controller. The Flow Chart in Section 10.0 provides an overview to the various menus and features. Keep a copy of the flow chart at hand when accessing the internal controller features.

Below is a description of the menu functions.

6.2.1 Menu Short Form

Since the 285X controller has a small LCD, some menu description may be in short form. The following are the menu descriptions:

Short Form	Description
<i>Diags:</i>	<i>Diagnostics</i>
<i>Cal Pts:</i>	<i>Calibration points</i>
<i>Auto Cal:</i>	<i>Auto calibrate</i>
<i>Man Cal:</i>	<i>Manual calibrate</i>
<i>Cal Ok:</i>	<i>Calibrate ok</i>
<i>Cal Err:</i>	<i>Calibrate err</i>
<i>mA out:</i>	<i>mA output</i>
<i>mA Span:</i>	<i>mA output span</i>
<i>Sec:</i>	<i>Seconds</i>
<i>ALRM CAL:</i>	<i>Alarm Calibration</i>
<i>Cal:</i>	<i>Calibration point</i>
<i>Net ID</i>	<i>Network Identification</i>

Short Form	Description
<i>SENSTVTY:</i>	<i>Sensitivity</i>
<i>A1:</i>	<i>Alarm relay 1</i>
<i>A2:</i>	<i>Alarm relay 2</i>
<i>Alrm:</i>	<i>Alarm</i>
<i>Alrm Lvl:</i>	<i>Alarm level</i>
<i>HiLv1:</i>	<i>Hi Differential alarm set value</i>
<i>LoLv1:</i>	<i>Lo Differential alarm set value</i>
<i>Delay:</i>	<i>Alarm Delay</i>
<i>^SP:</i>	<i>Relay Setpoint Hi action</i>
<i>vSP:</i>	<i>Relay Setpoint Low action</i>
<i>Dir:</i>	<i>Relay Action (Dir = Direct)</i>
<i>Fsafe:</i>	<i>Failsafe</i>

6.2.2 Menu Description

The 285X-LT controller will display the % **Level** value in its normal operating condition.

The 285X controller has a password protect feature. The default password is 2000. See section 6.3.1 “Password” if wish to have personal password.

From the main menu, you can select **Cal Only, View, and Change**.

Cal Only allows a two point calibration only. A password is required to enter this menu item and is described in the calibration section. Output parameters and other control features cannot be accessed through this menu. It is recommended to use this menu if only a re-calibration is to be done.

View allows an operator to view the **Calibration** setpoints in pF, the **Alarms** settings (2852 only) such as low or high action, failsafe or non-failsafe and the 0-600 second delay, the **Diagnostics** of raw readings and the **Setup** values such as mA output and ID address. This can be viewed without a password and without risk of changing any values. This information may be requested during technical assistance inquiries.

Change is password protected and allows an operator to change the configuration set-up values indicated in the View. Changes will be required for the initial setup of relay setpoints, delays, span etc. or to re-set the values to the factory default.

6.2.3 Data Entry

Data Entry

Press <▲> / <▼> key to increase / decrease the digital value.

Press <SELECT> key to move the cursor.

Press <MENU> key to abort certain screens.

6.3 285X Controller Setup

Power up the 285X Controller. The status LED should be green. The LCD will scroll to the normal operating screen after a series of the following screens (each displays for 2 sec.). * It may read % **Value** at normal condition or **Alarm** until a calibration is performed.

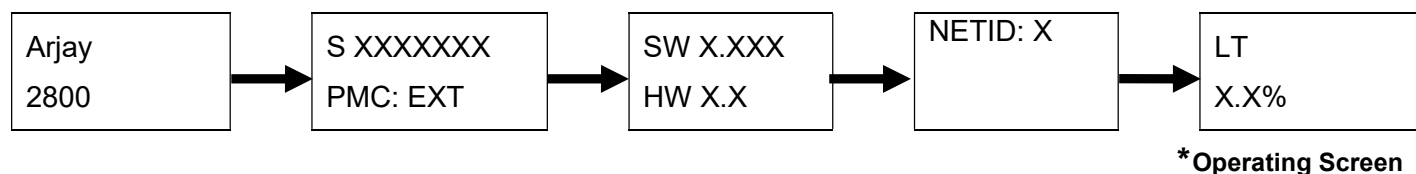

6.3.1 Setup And Network

The 285X Controller has the following factory default setup parameters. These are factory set to the requirements of the application. If changes to the parameter is required then they can be accessed in the CHANGE menu. Follow through the flowchart in section 10.0 and input the settings as required.

Press and Hold the menu key to enter the main menu. Follow the Flow Chart procedure to access the **Change** menu. Toggle to access the Setup menu.

1. mA Output Span

The mA output span may be set anywhere within the measurement range. Typically, the mA Span is set at the 100% level, but this span value can be changed to any required % level.

2. mA Output

For Direct mA output, 0% level = 4 mA, span level (e.g. 100%) = 20 mA;

For Inverse mA output, 0% level = 20 mA; span level = 4 mA.

The unit is shipped as Direct.

3. mA Type

The output can be set for 4-20mA or 0-20mA. The unit is shipped as 4-20mA.

4. PMC (A,K & C Values)

The PMC card has three personalized values that must be entered into the controller. These are factory entered at time of shipment. The three PMC values are indicated as A,K & C and are labeled on the PMC card installed at the probe but should be verified prior to calibration or any time a PMC card is changed out. Go to change menu.

5. Defaults

Factory settings are pre-configured into the unit based on the most typical set-up required for this application. This provides for a quick and easy calibration at site but can be changed to suit specific applications. If the setup has been field changed, selecting this will change back to the factory defaults.

6. NET ID

The ID number is used only for network applications. To communicate on a network, each controller must have a unique ID number. The factory default ID number is 1.

NOTICE

If multiple units on a network have the same address, network errors will result.

7. Filter

Data filtering is used to smooth data from a sudden change and minimize fluctuating readings. For example, a 5 second setting means the calculated value of the capacitance and resulting values of pF will start to respond immediately but will take 5 seconds to reach their final values. The factory default is 0 to provide an immediate and active response. This can be user selected from 0 - 99.9 seconds.

8. Password

The unit is shipped with password "2000". The user can continue to use this password or may change to a personal password after installation. To change password go to "Change" menu and toggle down to "Setup" menu then to "Password". Press Select. Enter new password. The password "2000" is no longer available. Consult factory if new password has been forgotten.

6.3.2 Relay Setup Menu

Press and Hold the menu key to enter the main menu. Follow the Flow Chart procedure to access the **Change** menu. Toggle to access the **Alarm** menu.

The 2852 Controller has 2 relays (A1 and A2) that allow 4 parameters per relay plus a time delay value, which is common to all relays:

1. HIGH ALARM (HiLv1) POINT. This value is specified in % level. Above this value, relay action is taken depending on the Relay Action and Failsafe settings. Factory default is 40% for A1 and 80% for A2.
2. LOW ALARM (LoLv1) POINT. This value should be less than the High control point. Below this value, relay action is taken depending on the Relay Action and Failsafe settings. Factory Default is 20% for A1 and 60% for A2.

3. **RELAY DELAY (Delay).** Minimum time in seconds for an alarm to exist before the corresponding relay changes to its alarm state. The relay alarm state depends on the Relay Action and Failsafe settings. Factory default is 0.
4. **RELAY ACTION (Dir).** High Δ sp or Low ∇ sp Action. For high action, the alarm is set when the % level rises above the high alarm set point and is reset when the % level drops below the low alarm set point. For low action, the alarm is set when the % level drops below the low alarm set point and is reset when % level rises above the high alarm set point. Factory default is HIGH action.
5. **FAILSAFE (Fsafe).** Failsafe typically means that the relay is normally (when not in an alarm condition) held in an energized state. In an alarm condition, the relay is de-energized i.e. identical to when the instrument power is shut off. The rationale is that the alarm condition should match the Power Fail condition. Factory default is Yes.

The following table shows the effect of the Relay Action and Failsafe settings.

Relay Action	Failsafe Setting	Effect
High	No	Alarm condition when process level rises above the High Setpoint for at least the alarm delay period. Alarm condition remains active until the process level drops below the Low Setpoint. No action is taken when the process level is between the High and Low Setpoints. In the alarm condition, the corresponding alarm LED is turned ON, and the relay is energized.
High	Yes	Alarm condition set and reset as above. In the alarm condition, the corresponding alarm LED is turned ON, and the relay is de-energized.
Low	No	Alarm condition when process level drops below the Low Setpoint for at least the alarm delay period. Alarm condition remains active until the process level rises above the High Setpoint. No action is taken when the process level is between the High and Low Setpoints. In the alarm condition, the corresponding alarm LED is turned ON, and the relay is energized.
Low	Yes	Alarm condition set and reset as above. In the alarm condition, the corresponding alarm LED is turned ON, and the relay is de-energized.

6.4 285X Controller Calibration

6.4.1 Auto Calibration

For the controller calibration the present tank level, in %, must be known. The % value will be entered and the tank level must then be changed, up or down, by at least 10%. The new level, in %, will then be entered as the second and final point.

Following the Menu Flow Chart, enter “Cal only” menu, then “Auto Cal”.

See section 6.2.3 for DATA entry setups.

1. In the 1st point entry menu, enter the current level value in % (e.g. 000.0%, or 50.0%). Confirm the capacitance value in pF is stabilized, press <SELECT> key to accept the 1st point value. The cursor will move across and accept the 1st Cal point after the last digit of value entered. The 1st calibration point has been done. The LCD will scroll to the 2nd % point entry menu.
2. CHANGE THE LEVEL IN THE VESSEL BY A MINIMUM OF 10.0%. The level may be raised or lowered. A change of less than 10.0% may be used in some applications but is not recommended to ensure calibration accuracy. The capacitance value in pF will increase if raising the level or decrease if lowering the level.
3. In the 2nd point entry menu, enter the new current level value in % (e.g. 100.0%, or 30.0%). Confirm the capacitance value in pF (Bottom line) is stabilized, press <SELECT> key to accept the 2nd point value. The cursor will move across and accept the 2nd Cal point after the last digit of value entered. The 2nd calibration point has been done.

If the calibration is successful, the display will show “Cal Ok” for a couple of seconds and then return to the calibration menu. If the display shows “Cal Err”, then a calibration fault has occurred. Check the following:

1. The 2nd level entry value is accidentally left at the 1st calibration point % level.
 - Re-do the auto calibration according to the above steps 1 – 3.
2. The level in the vessel was not changed from the 1st calibration point.
 - Re-do the auto calibration according to the above steps 1 – 3.
3. If 1 or 2 are not the cause call Arjay Engineering Ltd.: Toll free: (800) 387-9487 (North America Only), tel. +1 (905) 829-2418.

6.4.2 Manual Calibration

Manual Calibration allows you to override the values that have been set through the automatic calibration. This feature may be used for a number of different reasons. For example.

1. One of the calibration points is desired to be re-calibrated. The user can view the pF reading of the probe in the Diagnostics menu and also record the actual level in the vessel at the same time. These values can then be entered in the Manual Calibration to change either Cal Point 1 or Cal Point 2.
2. If a calibration was done using 20% and 60 % as the two values (for example), but it was later determined that the 60% should have been entered as 70%.
3. The process level cannot be altered at the time of calibration so a random pF value and % level value is entered as the second point to allow operations until a proper second point can be entered. See method in 1 above.

***THIS COMPLETES THE SETUP & CALIBRATION PROCEDURE FOR THE
285X-LT SERIES CAPACITANCE LEVEL TRANSMITTER***

7.0 CONTROLLER NETWORK

The *28XX series Transmitter may be monitored and calibrated via RS-485 protocol compatible digital communications.

Typical features are:

1. Ease of wiring in multiple level point monitoring:

Up to 255 of Arjay *28XX Series transmitter or monitor may be connected together in a daisy chain (2 wire communication plus power wiring) connection to an Arjay Remote Access monitor or customer control system which allows viewing data and setup of any of the transmitters on the network. The 4-20mA output may still be used if necessary.

2. Setup for the *28XX for network operation:

Each *28XX controller must have a unique number to connect in a network system. See section 10.0 Menu Flow Chart, CHANGE menu for details to change the ID number.

***Where "XX" = 51 or 52**

7.1 MODBUS Configuration

Parameter settings: 9600 Baud Rate; Even Parity, 8 Data Bits and 1 Stop Bit.

Wiring connection: RS485 (+) connect to D+; RS485 (-) connect to D-.

See section 7.2 for Modbus Register mapping.

7.2 2800 Series MODBUS Register Mapping

REG	Zero Based	DESCRIPTION	TYPE	No. of Reg	Note
40001	0	Serial Number	float	2	
40003	2	Hardware Rev / Software Rev	byte	1	
40004	3	Spare / Mode	byte	1	
40005	4	Sensitivity A2 / Sensitivity A1	byte	1	Optional
40006	5	Instrument Status 1 / Instrument Status 0	byte	1	
40007	6	Model type / Modbus ID address	byte	1	
40008	7	Relay2 Setup / Relay 1 Setup	byte	1	
40009	8	Password	int	1	
40010	9	XA "A" cal parameter	float	2	
40012	11	XK "K" cal parameter	float	2	
40014	13	XC "C" cal parameter	float	2	
40016	15	Filter	float	2	
40018	17	Slope - pF per% level	float	2	Optional
40020	19	Offset - pF for empty vessel	float	2	Optional
40022	21	mA output span value	float	2	Optional
40024	23	mA output zero value	float	2	Optional
40026	25	mA output Trim Slope value	float	2	
40028	27	mA output Trim Offset value	float	2	
40030	29	Cal1 PV: Level calibration: 1st level point in %	float	2	Optional
40032	31	Cal2 PV: Level calibration: 2nd level point in %	float	2	Optional
40034	33	Cal1 pF: Level calibration: 1st capacitance value in pF	float	2	Optional
40036	35	Cal2 pF: Level calibration: 2nd capacitance value in pF	float	2	Optional
40038	37	Relay 1 : Differential High Alarm.	float	2	Optional
40040	39	Relay 2: Differential High Alarm.	float	2	Optional
40042	41	Relay 1: Differential Low Alarm.	float	2	
40044	43	Relay 2: Differential Low Alarm.	float	2	
40046	45	Relay 1 On delay [seconds]	int	1	
40047	46	Relay 2 On delay [seconds]	int	1	
40048	47	mA Analog Output	float	2	Optional
40050	49	Osc. Frequency	float	2	
40052	51	Frequency	float	2	
40054	53	Capacitance	float	2	
40056	55	Filtered Capacitance	float	2	
40058	57	Level	float	2	Optional
40060	59	Compensated pF for point level if enable Temperature compensation	float	2	Optional
40062	61	Temperature in mV	float	2	Optional
40064	63	Temperature in degree C	float	2	Optional
40066	65	Compensation factor: percent per degree	float	2	Optional
40068	67	Temperature at Calibration	float	2	Optional
40070	69	Temperature offset [mV at 0 dC]	float	2	Optional
40072	71	Temperature slope [mV per dC]	float	2	Optional
40074	73	Alarm 1 differential Off value	float	2	Optional
40076	75	Alarm 2 differential Off value	float	2	Optional

8.0 MAINTENANCE

There is no routine cleaning required for this controller.

9.0 TROUBLESHOOTING

CONDITION	DO THIS
1. Status LED is OFF and the LCD display is off	Check the power to the unit. If the unit is a 12VDC or 24VDC model, check the external source and polarity is correct. If the unit is a 100-240VAC model, then check the Line, Neutral and Ground wiring is correct.
2. If the status LED is RED	<p>This indicates a major error such as memory failure, no probe signal etc. Check the following:</p> <ul style="list-style-type: none"> • Make sure the PMC is installed & the PMC wiring is correct and there are no breaks in the wiring. At the controller, measure across the Probe Input terminals with a DC meter. Make sure “Common” lead of meter is on ‘-’ terminal. It should read (+) 8 to (+) 10 VDC with the PMC connected and approximately 20 to 24 VDC with the PMC terminal disconnected. • Microprocessor may have lost its parameters due to a power surge in the line. Go to Diagnostic in view Menu (see section 10.0 Flow Chart) to check the Calibration values, frequency and capacitance values then, call Arjay Technical Support.
3. No mA output OR incorrect mA output.	<p>IMPORTANT: THE UNIT SOURCES mA OUT FROM THE mA OUTPUT TERMINAL. <u>THIS TERMINAL SHOULD NOT BE CONNECTED TO +24V.</u> IT IS NOT A 2 WIRE mA TRANSMITTER. See Figure 3 for Electrical hookup details.</p> <ul style="list-style-type: none"> • Disconnect external wires from mA output and measure with mA Meter. • Check the mA output Action (direct or inverse) and mA output Span are set as desired. See section 10.0 Flow chart / Change menu. • If the mA output still does not match the level, then call Arjay Technical Support.
4. Level reading is not correct	<ul style="list-style-type: none"> • Make sure probe is properly grounded to Tank. • Ensure that there is a parallel ground reference with probe via Tank wall or concentric shield. • Go to View Menu, then select CAL. Write down the %level and pF reading of each CAL point. Go to DIAG menu and verify existing pF reading. If pF reading is within range of CAL point then unit can be trimmed by Entering a new CAL point in manual CAL under change menu. If pF way out of range then check what changes may have occurred since initial CAL. E.G. different material, new location for probe, Temperature.
5. CAL Error No Change	<ul style="list-style-type: none"> • Make sure blue wire from probe end is connected to “P” terminal plug of PMC2800. • Make sure level is changing in tank when performing 2nd Cal point.
6. “NO SENSOR”	<ul style="list-style-type: none"> • Capacitance reading is less than 5pF. • Verify that the blue probe wire is connected to “P” terminal plug of PMC2800 Probe input.

ARJAY ENGINEERING TECHNICAL SUPPORT

(800) 387-9487

+1 (905) 829-2418

www.arjayeng.com

10.0 FLOW CHARTS

NORMAL OPERATING DISPLAY

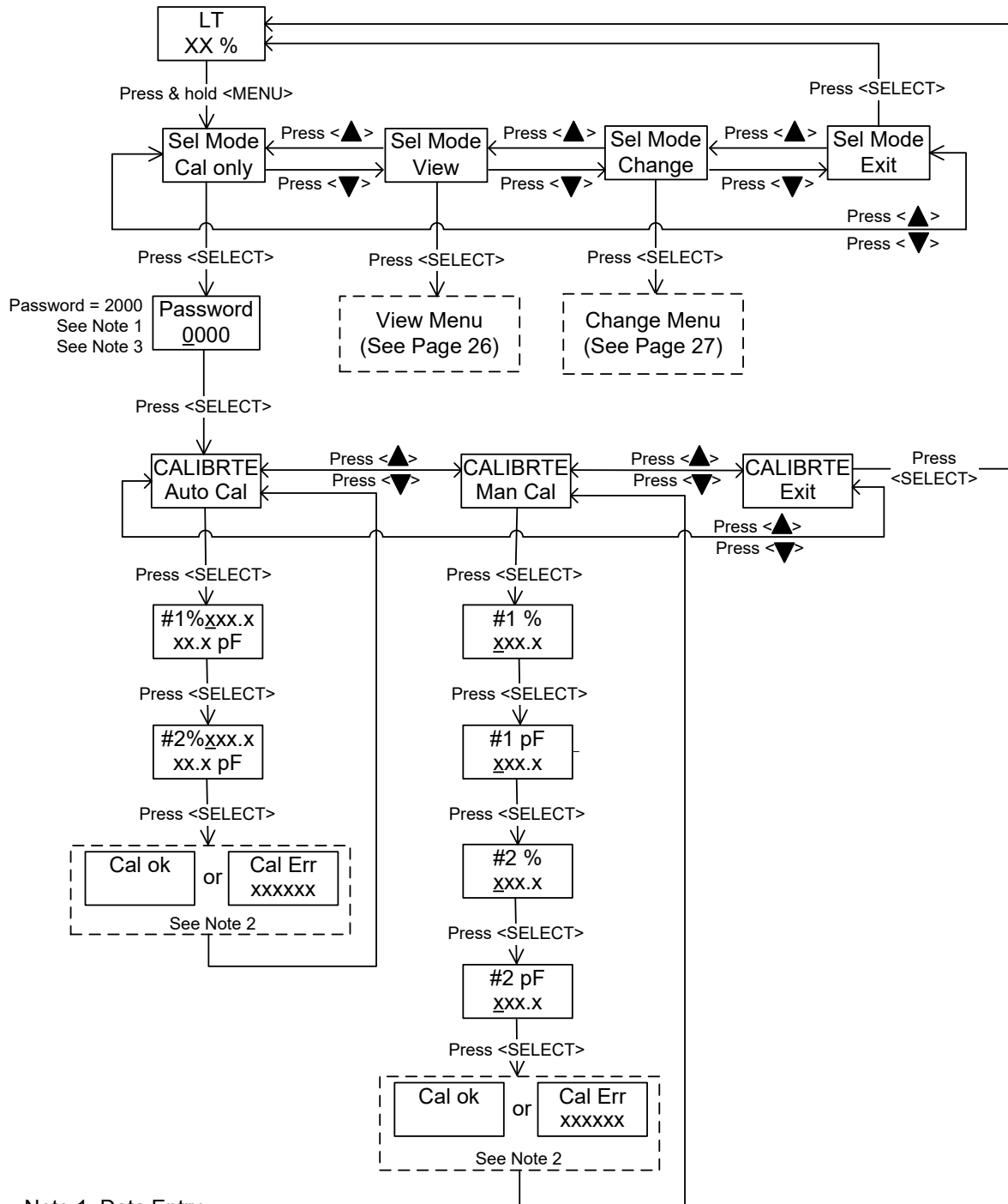

Note 1: Data Entry

"_" Flash cursor indicates to entry the value

Press <▲> / <▼> key to increase / decrease the digital value.

Press <SELECT> key to move the cursor.

Note 2: Calibration information, it only shows about 2 seconds

Note 3: See section 6.3.1 step 7 if password has changed.

VIEW MENU

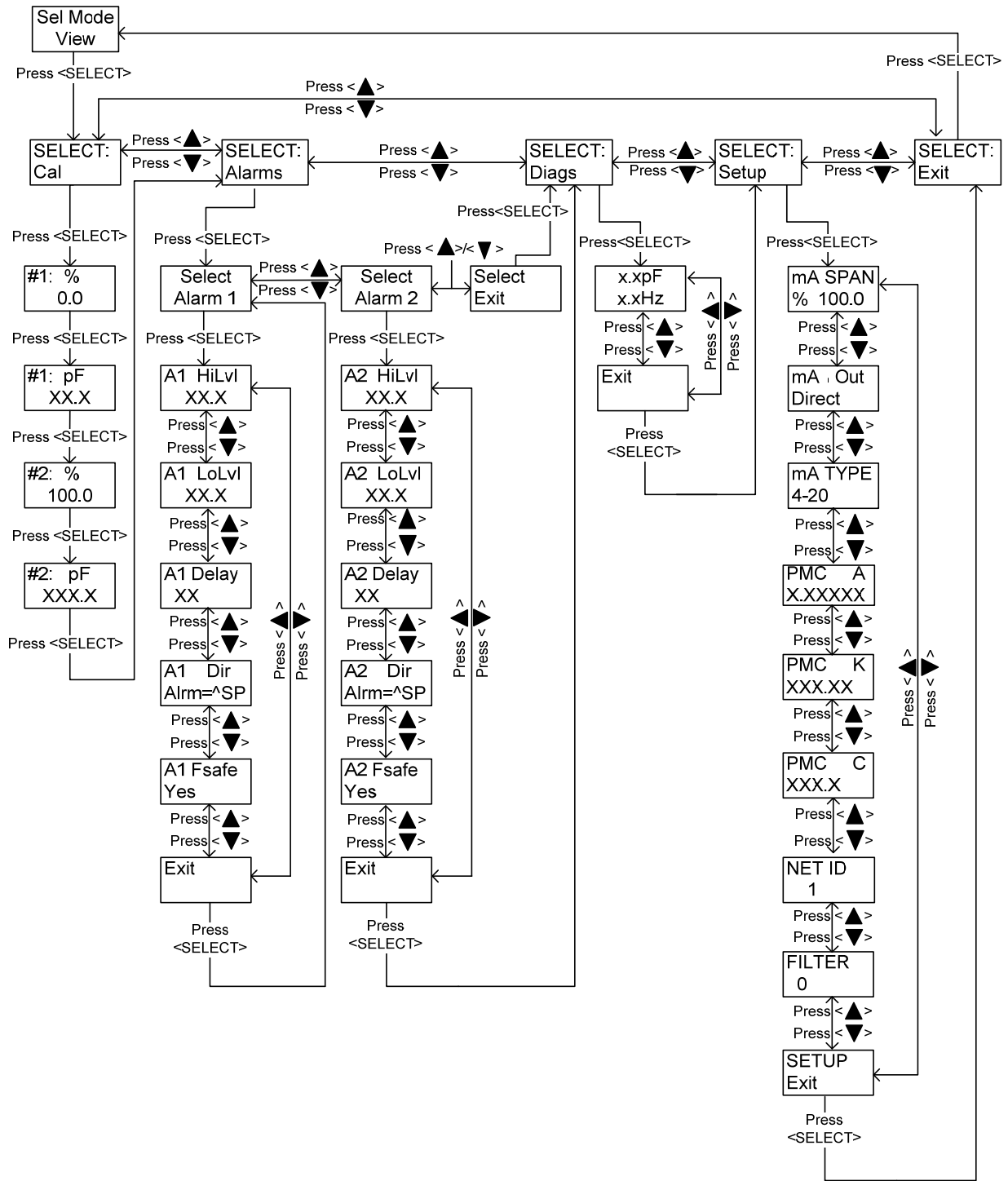

CHANGE MENU

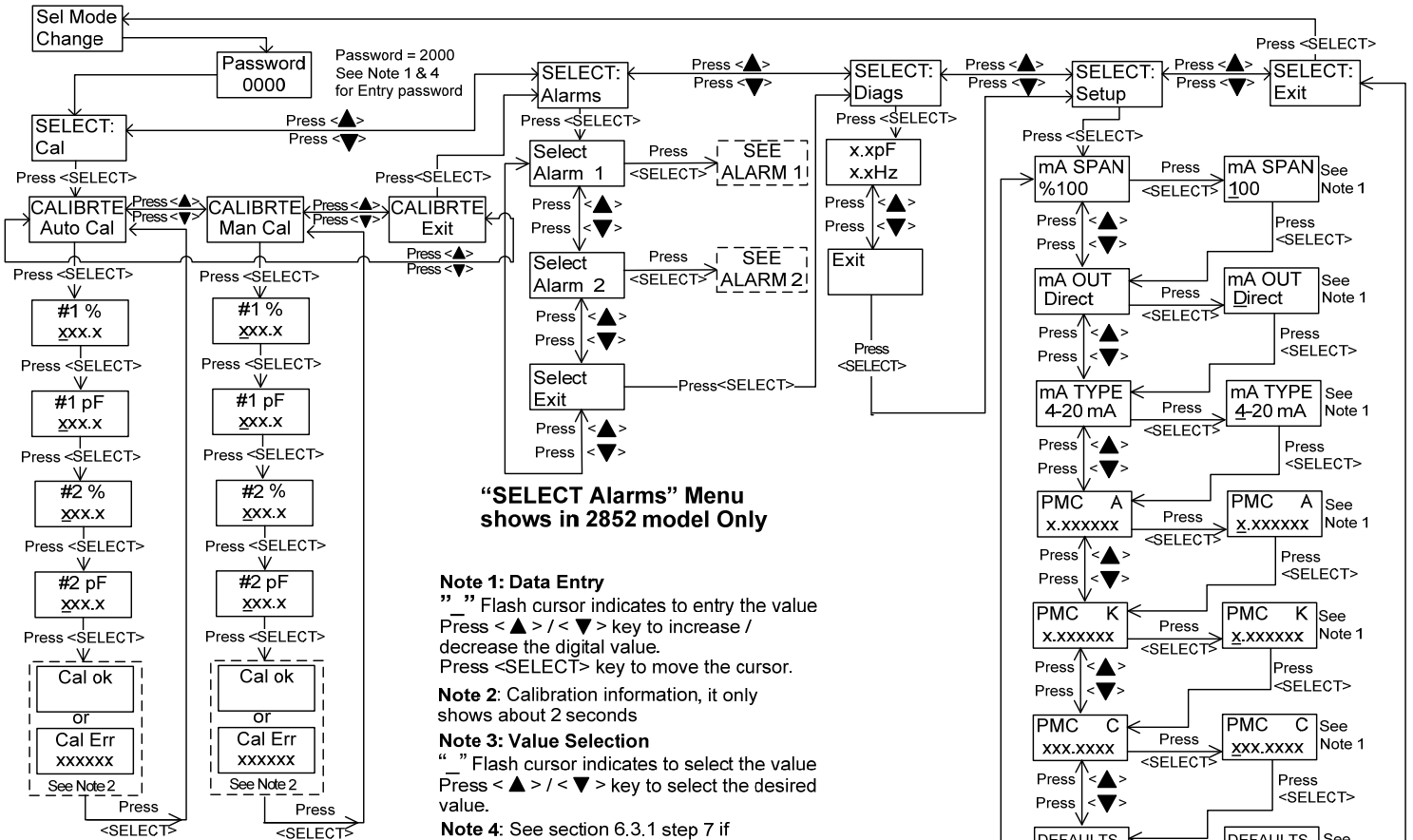

ALARM 1

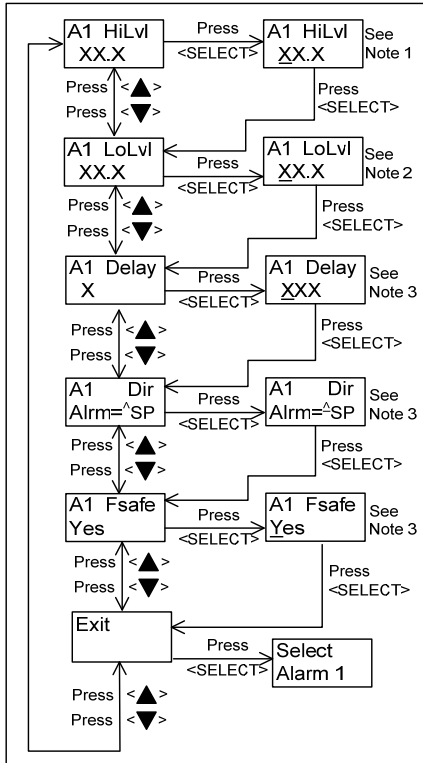

ALARM 2

